

Typical performance

- Constant voltage input, isolated unregulated output, power 1W
- Isolation voltage: 1500VDC
- Low no-load power consumption: 0.025W (Typ.)
- Efficiency: up to 90%
- Working environment temperature: -40°C~+85°C
- Failure-free time MTBF≥3.5 million hours (3500000Hrs)
- Output short circuit protection: continuous short circuit protection, automatic recovery
- Small SIP package, plastic housing
- International standard pin mode
- Ripple/Noise (20MHz bandwidth): 30mVp-p(Typ.)

1W, constant voltage input,
 isolated unregulated single output
 DC-DC power module

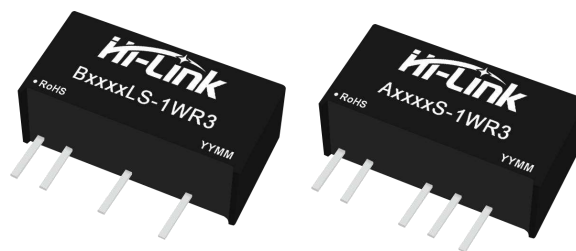

Over temperature protection and
 output continuous short circuit protection
 RoHS

B_LS-1WR3&A_S-1WR3 series are small size, high-efficiency micro power, constant voltage input, isolated and unregulated single/dual output, DC/DC module power supply provided by Hi-link. This series of products is specially designed for applications in on-board power systems that need to generate a set of voltages that are isolated from the input power supply. This product is suitable for

- The voltage of the input power supply is relatively stable (voltage variation range $\pm 10\%V_{in}$);
- Isolation is required between input and output (isolation voltage $\leq 1500VDC$);
- The requirements for output voltage stability are not high;
- Typical applications: pure digital circuits, general low-frequency analog circuits, relay drive circuits, data exchange circuits, etc.

Product Coding Rules

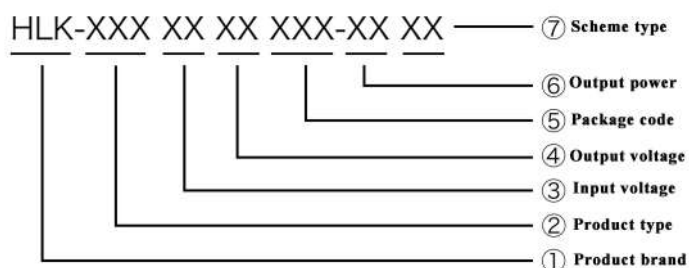

Product List

Certificate	Product Module number ^①	Input Voltage range (Vdc)		Output Voltage/Current		Ripple and Noise	Efficiency @ full load	Maximum capacitive load
		Nominal value ^②	(range value)	Output voltage (Vdc)	Output current (mA) (Max.Min.)	Full load (mVp-p) Typ/Max.	%, (Min/Typ)	uF
	A0303S-1WR3	3.3		±3.3	±152/±15	30/80	76/80	1200
	A0305S-1WR3		(2.97~3.63)	±5	±100/±10	30/80	86/88	1200

A0309S-1WR3		±9	±56/±6	30/80	87/89	560	
A0312S-1WR3		±12	±42/±5	30/80	87/89	330	
A0315S-1WR3		±15	±34/±4	30/80	87/89	330	
A0324S-1WR3		±24	±21/±3	30/80	87/89	100	
B0303LS-1WR3		3.3	303/30	30/80	76/80	2400	
B0305LS-1WR3		5	200/20	30/80	80/84	2400	
B0312LS-1WR3		12	84/9	30/80	84/86	560	
A0503S-1WR3		5 (4.5-5.5)	±3.3	±152/±15	30/80	76/80	1200
A0505S-1WR3			±5	±100/±10	30/80	86/88	1200
A0509S-1WR3			±9	±56/±6	30/80	87/89	560
A0512S-1WR3			±12	±42/±5	30/80	87/89	330
A0515S-1WR3			±15	±34/±4	30/80	87/89	330
A0524S-1WR3	±24		±21/±3	30/80	87/89	100	
B0503LS-1WR3	3.3		303/30	30/80	76/80	2400	
B0505LS-1WR3	5		200/20	30/80	86/88	2400	
B0509LS-1WR3	9		111/12	30/80	87/89	1000	
B0512LS-1WR3	12		84/9	30/80	87/89	560	
B0515LS-1WR3	15		67/7	30/80	87/89	560	
B0524LS-1WR3	24		42/4	30/80	87/89	220	
A1203S-1WR3	12 (10.8~13.2)	±3.3	±152/±15	30/80	76/80	1200	
A1205S-1WR3		±5	±100/±10	30/80	86/88	1200	
A1209S-1WR3		±9	±56/±6	30/80	87/89	560	
A1212S-1WR3		±12	±42/±5	30/80	87/89	330	
A1215S-1WR3		±15	±34/±4	30/80	87/89	330	
A1224S-1WR3		±24	±21/±3	30/80	87/89	100	
B1203LS-1WR3		3.3	303/30	30/80	76/80	2400	
B1205LS-1WR3		5	200/20	30/80	86/88	2400	
B1209LS-1WR3		9	111/12	30/80	87/89	1000	
B1212LS-1WR3		12	84/9	30/80	87/89	560	
B1215LS-1WR3		15	67/7	30/80	87/89	560	
B1224LS-1WR3		24	42/4	30/80	87/89	220	
A1503S-1WR3	15 (13.5~16.5)	±3.3	±152/±15	30/80	76/80	1200	
A1505S-1WR3		±5	±100/±10	30/80	86/88	1200	
A1509S-1WR3		±9	±56/±6	30/80	87/89	560	
A1512S-1WR3		±12	±42/±5	30/80	87/89	330	
A1515S-1WR3		±15	±34/±4	30/80	87/89	330	
A1524S-1WR3		±24	±21/±3	30/80	87/89	100	
B1503LS-1WR3		3.3	303/30	30/80	76/80	2400	
B1505LS-1WR3		5	200/20	30/80	86/88	2400	
B1509LS-1WR3		9	111/12	30/80	87/89	1000	

B1512LS-1WR3	24 (21.6~26.4)	12	84/9	30/80	87/89	560
B1515LS-1WR3		15	67/7	30/80	87/89	560
B1524LS-1WR3		24	42/4	30/80	87/89	220
A2403S-1WR3		±3.3	±152/±15	30/80	76/80	1200
A2405S-1WR3		±5	±100/±10	30/80	86/88	1200
A2409S-1WR3		±9	±56/±6	30/80	87/89	560
A2412S-1WR3		±12	±42/±5	30/80	87/89	330
A2415S-1WR3		±15	±34/±4	30/80	87/89	330
A2424S-1WR3		±24	±21/±3	30/80	87/89	100
B2403LS-1WR3		3.3	303/30	30/80	76/80	2400
B2405LS-1WR3		5	200/20	30/80	86/88	2400
B2409LS-1WR3		9	111/12	30/80	87/89	1000
B2412LS-1WR3		12	84/9	30/80	87/89	560
B2415LS-1WR3		15	67/7	30/80	87/90	560
B2424LS-1WR3		24	42/4	30/80	87/90	220

Note: 1. Due to limited space, the above is just a list of typical products. If you need products other than the list, please contact the sales department of our company.

2. The maximum capacitive load indicates the maximum capacitive load that can be connected to +Vo or -Vo. If it exceeds this value, the product will not be able to start normally.

Test conditions: Without specified needs, all parameter tests are measured at nominal input voltage, purely resistive rated load and 25°C room temperature.

Input Characteristics

Items	Working conditions	Min.	Typ.	Max.	Unit
Input current (fully loaded/ unloaded)	3.3VDC Input	--	378/6	--/12	mA
	5VDC Input	--	224/5	--/10	
	12VDC Input	--	93/3	--/5	
	15VDC Input	--	74/2	--/4	
	24VDC Input	--	47/1	--/2	
Reflected Ripple Current		--	15	--	mA
Impulse voltage (Isec.max)	3.3VDC Input	-0.7	--	5	VDC
	5VDC Input	-0.7	--	9	
	12VDC Input	-0.7	--	18	
	15VDC Input	-0.7	--	21	
	24VDC Input	-0.7	--	30	
Input filter type		Capacitive filtering			
Hot plug		Not available			

Output Characteristics

Items	Working and test conditions	Min.	Typ.	Max.	Unit	
Output load	Load percentage	10	--	100	%	
Output Voltage Accuracy	Refer to Error Envelope Curve	--	--	±15.0	%	
Linear adjustment rate	Input voltage variation ±1%	3.3V Output	--	--	±1.5	%
		Others	--	--	±1.2	%
Load Regulation	10%~100% Load	3.3VDC Output	--	18	--	%
		5VDC Output	--	12	--	%
		9VDC Output	--	8	--	%
		12VDC Output	--	7	--	%
		15VDC Output	--	6	--	%
		24VDC Output	--	5	--	%
Ripple & Noise	Pure resistive load, 20MHz bandwidth, peak-to-peak	--	30	80	mVp-p	
Temperature Drift Coefficient	Full load	--	--	±0.03	%/°C	
Output short circuit protection	Continuous short circuit protection, automatic recovery					

Note: ①The test method of ripple and noise is twisted pair test method.

General Characteristics

Items	Working conditions	Min.	Typ.	Max.	Unit
Insulation voltage	Input-output, test time is 1 minute, leakage current is less than 1mA	1500	--	--	VDC
Insulation resistance	Input-output, insulation voltage 500VDC	1000	--	--	MΩ
Isolation capacitor	Input-output, 100KHz/0.1V	--	20	--	pF
Operating temperature	Refer to Temperature Derating Curve	-40	--	+85	°C
Storage temperature		-40	--	+125	
Shell temperature rise during operation		--	25	--	
Storage humidity	No condensation	5	--	95	%RH
Pin soldering temperature	The solder joint is 1.5mm away from the shell, 10 seconds	--	--	+300	°C
On-off level	Full load, nominal voltage input	--	100	--	KHz
Shock		10-55Hz, 10G, 30Min.along X, Y and Z			
Shell material		Black flame retardant heat resistant plastic (UL94V-0)			
Minimum time between failures	MIL-HDBK-217F@25°C	3.5X10 ⁶	--	--	Hrs

Product characteristic curve

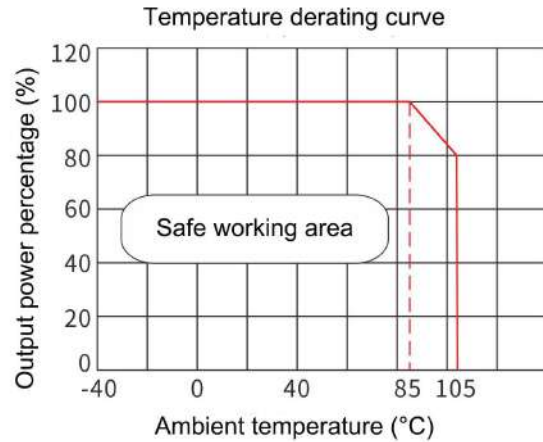
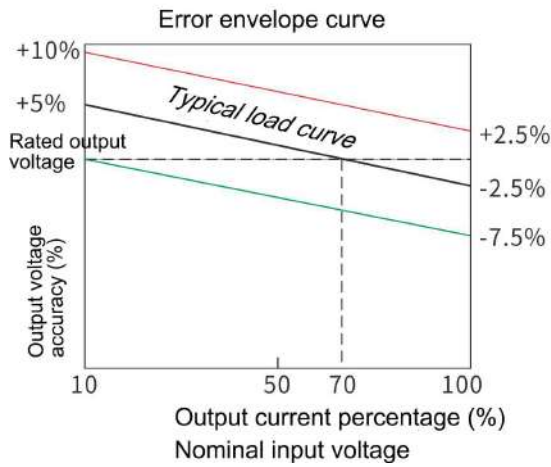

Typical Application Reference Circuit (Recommended Parameters)

1. General application:

If it is required to further reduce the input and output ripple, a capacitor filter network can be connected to the input and output ends, and the application circuit is shown in Figure 1.

However, attention should be paid to the selection of appropriate filter capacitors. If the capacitor is too large, it is likely to cause startup problems. For each output, under the condition of ensuring safe and reliable operation, the recommended capacitive load value is shown in Table 1

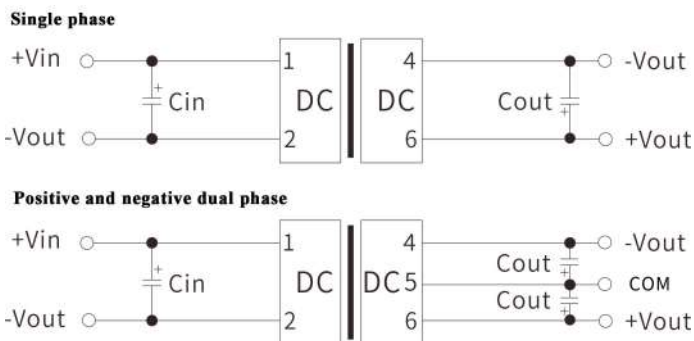

Figure 1

Vin (Vdc)	Cin (uF)	Vo (Vdc)	Cout (uF)
3.3/5	4.7	3.3/5	10
12	2.2	9	4.7
15	2.2	12	2.2
24	1	15	1
-	-	24	0.47

2. EMI typical application circuit

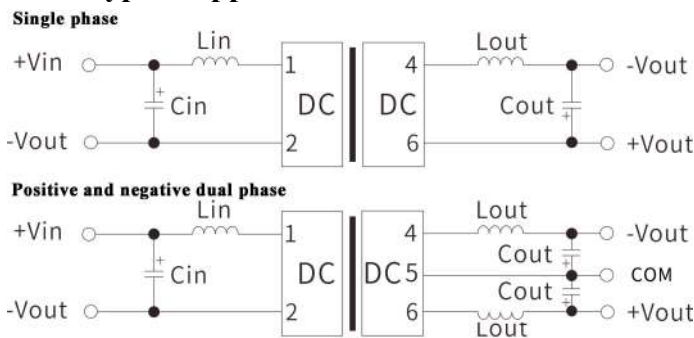

Figure 2

Recommended EMI Reference Circuit Values (Table 2)

Vin (Vdc)	3.3/5/12/15/24
Cin	4.7uF/50V
Cout	Refer to Table 1
Lin	4.7uH
Lout	4.7uH

3. Output load requirements

In order to ensure that the module can work efficiently and reliably, the minimum output load cannot be less than 10% of the rated load when in use. If the power you need is really small, please connect a resistor in parallel between the positive and negative poles of the output terminal (the sum of the actual power used by the resistor is greater than or equal to 10% of the rated power and the rated power of the selected resistor must be greater than 5 times the actual power used, otherwise the temperature of the resistor will be higher).

Product appearance size and pin definition, recommended printing layout

1) Size (unit: mm, error: ± 0.25)

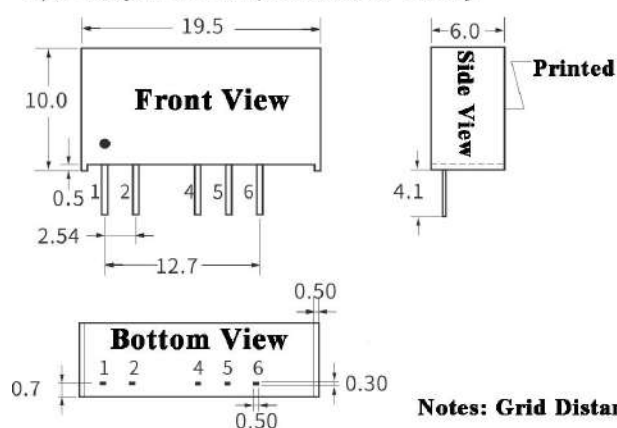

2) Pin definition

PIN	1	2	3	4	5	6
Single phase	+Vin	-Vin	No Pin	-Vout	No Pin	+Vout
	Input P.	Input N.	NC	Output N.	NC	Output P.
Dual phase	+Vin	-Vin	No Pin	-Vout	COM	+Vout
	Input P.	Input N.	NC	Output N.	Public place	Output P.

3) Recommended print layout

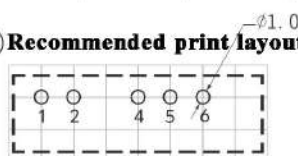

P. is Positive, N. is Negative

Notes: Grid Distance: 2.54*2.54mm

Note: If the definition of each pin of the power module is inconsistent with the selection manual, the label on the physical label shall prevail.

Package description

Package code	LxWxH	
LS	19.50x6.0x10.0mm	0.768x0.236x0.394inch

Test Application Reference

Ripple and noise test (Twisted pair method, 20MHZ bandwidth)

Testing method:

(1) Ripple noise is connected by 12# twisted pair. The oscilloscope bandwidth is set to 20MHz, 100M bandwidth probe, and 0.1uF polypropylene capacitor and 47uF high frequency low resistance electrolytic capacitor are connected in parallel on the probe end.

The oscilloscope sampling uses Sample sampling mode.

(2) Schematic diagram of output ripple&noise test:

Connect the power input terminal to the input power supply terminal.

The power output is connected to the electronic load through the fixture board. The test uses a 30cm \pm 2 cm sampling line to sample directly from the power output port. The power line selects the insulated wire with the corresponding wire diameter according to the magnitude of the output current.

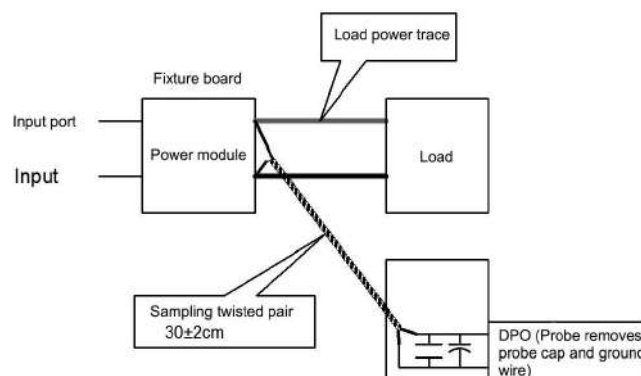

Application considerations

1. Input requirements: Ensure that the output voltage fluctuation range of the power supply does not exceed the input requirements of the DC / DC module itself, and the output power of the input power supply must be greater than the output power of the DC / DC module.
2. One recommended circuit: For applications where ripple and noise requirements are normal, a filter capacitor can be connected in parallel at the input and output ends. The external circuit is shown in the following figure1 with the recommended value details of the filter capacitor. Output load requirements: Try to avoid no-load use. When the actual power consumption of the load is less than 10% of the rated output power of the module or there is no-load phenomenon, it is recommended that a dummy load be connected to the output end. The dummy load (resistance) can be calculated by $5\sim 10\%$ of the rated power of the module, resistance value = $U_{out} / (1WR3 * 10\%)$.
3. Overload protection: Under normal working conditions, the output circuit of this product has no protection function for overload conditions; when long-term overload, over-temperature protection will be provided and the output will be turned off
4. Output continuous short-circuit protection, automatic recovery.
5. The external capacitor of the output terminal should not be too large, otherwise it will easily cause over-current or poor start-up when the module starts.
6. If the product works below the minimum required load, the performance of the product cannot be guaranteed to meet all performance indications in this manual.
7. The maximum capacitive load is tested under the input voltage range and full load condition.
8. Unless special instructions, all indexes in this manual are measured at the condition, $T_a = 25\text{ }^\circ\text{C}$, humidity $<75\%$ RH, nominal input voltage and output rated load.
9. All index testing methods in this manual are based on the company's standards
10. Our company can provide product customization, and you can directly contact our technical staff for specific conditions
11. Product specifications are subject to change without notice.

Contact

Shenzhen Hi-Link Electronic Co., Ltd

Add: 3rd Floor, Building 1, 1970 Science and Technology Park, Minzhi, Longhua District, Shenzhen, Guangdong, China
518131

Website: www.hlktech.net

E-mail: sales@hlktech.com

Tel: 0755-23152658