

PNP型 小功率 贴片三极管 PNP High Voltage Transistor SMD	SS8550 对应其他工业型号
<ul style="list-style-type: none"> ■ Transistor Polarity: PNP ■ Transistor pinout: BEC ■ SOT-23 Package ■ Marking Code: Y2 ■ hFE: 100~200, 200~300 ■ Ideal for Medium Power Amplification and Switching 	

Inner circuit  SOT-23 内部结构	SS8550  SOT-23 管脚排列	元件标识 (打印)  DEVICE MARKING:
--	--	--

■ CLASSIFICATION OF hFE

RANK	L	H
RANGE	100~200	200~300

■ MAXIMUM RATINGS

Symbol	Parameter	Value	Unit
V_{CBO}	Collector-Base Voltage	-40	V
V_{CEO}	Collector-Emitter Voltage	-25	V
V_{EBO}	Emitter-Base Voltage	-6	V
I_C	Collector Current	-1500	mA
P_C	Collector Power Dissipation	300	mW
T_J, T_{stg}	Operation Junction and Storage Temperature Range	-55~+150	°C

■ ELECTRICAL CHARACTERISTICS (T_A=25°C unless otherwise noted)

Characteristic	Test Condition	Symbol	Min	Typ	Max	Unit
Collector-Emitter Breakdown Voltage	I _B =0, I _C =-1mA	V _{(BR)CEO}	-25	--	--	V
Collector-Base Breakdown Voltage	I _E =0, I _C =-100μA	V _{(BR)CBO}	-40	--	--	V
Emitter-Base Breakdown Voltage	I _E =0, I _C =-10μA	V _{(BR)EBO}	-6	--	--	V
Emitter Cutoff Current	V _{CE} =-3V, V _{EB} =-0.4V	I _{BEO}	--	--	-50	μA
Collector Cutoff Current	V _{CE} =-120V, V _{EB} =-0.4V	I _{CBO}	--	--	-50	μA
DC Current Gain	I _C =-1mA, V _{CE} =-5V	hFE	50	--	--	
	I _C =-10mA, V _{CE} =-5V	hFE	60	--	--	
	I _C =-50mA, V _{CE} =-5V	hFE	30	--	--	
Collector-Emitter Saturation Voltage	I _C =-10mA, I _B =-1mA	V _{CE(sat)}	--	--	-0.2	V
	I _C =-50mA, I _B =-10mA	V _{CE(sat)}	--	--	-0.5	V
Base -Emitter Saturation Voltage	I _C =-150mA, I _B =-1mA	V _{BE(sat)}	--	--	-1.0	V
	I _C =-50mA, I _B =-5mA	V _{BE(sat)}	--	--	-1.0	V
Current-Gain-Bandwidth Product	I _C =-10mA, V _{CE} =-10V, f=100MHz	f _T	100	--	300	MHz
Output Capacitance	V _{CB} =-10V, I _E =0, f=1MHz	C _{obo}	--	--	6.0	pF
Small-Signal Current Gain	I _C =-1mA, V _{CE} =-10V, f=1kHz	hFE	40	--	200	
Noise Figure	V _{CE} =-5V, I _C =-200μA, R _s =1KΩ, f=1.0KHz	NF	--	--	8.0	dB

1. FR-5 = 1.0 × 0.75 × 0.062 in.

2. Alumina = 0.4 × 0.3 × 0.024 in.99.5% alumina.

3. Pulse Width ≤ 300us; Duty Cycle ≤ 2.0%.

■ TYPICAL CHARACTERISTICS

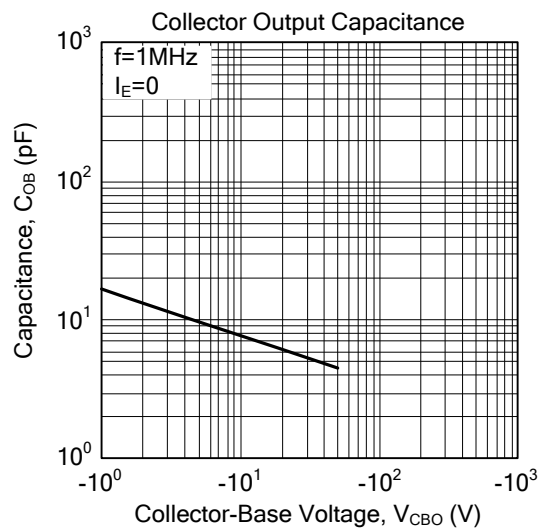
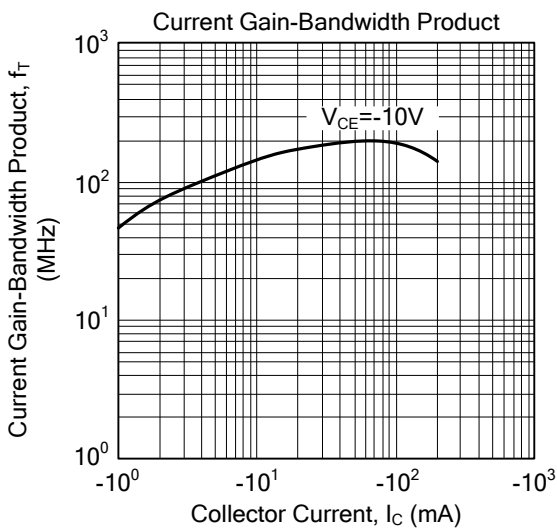
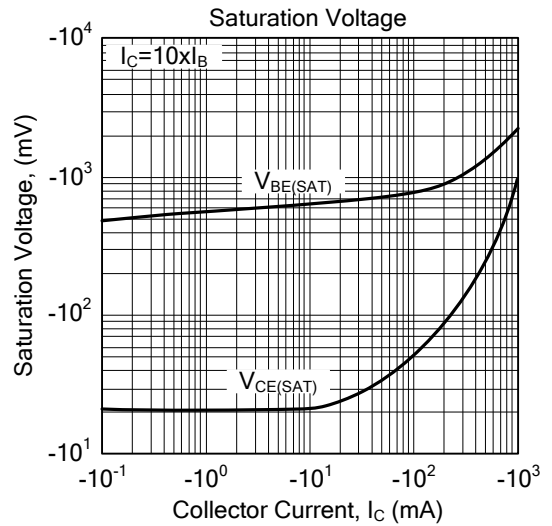
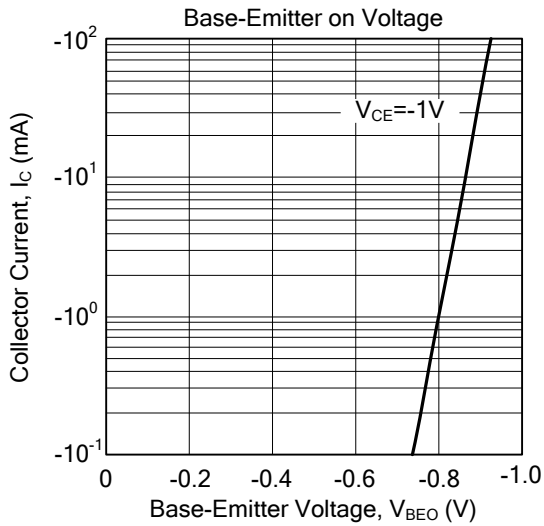
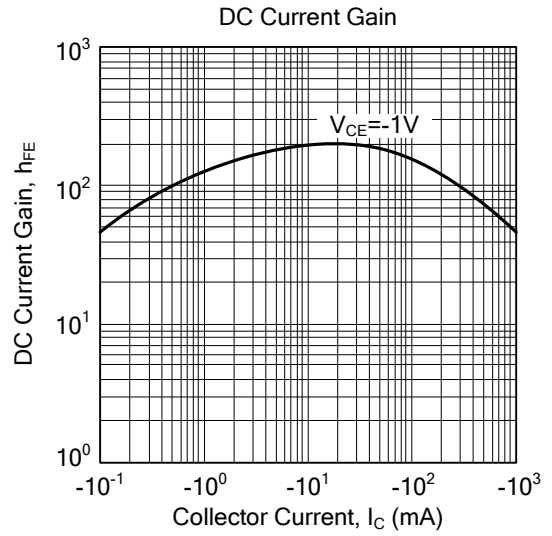
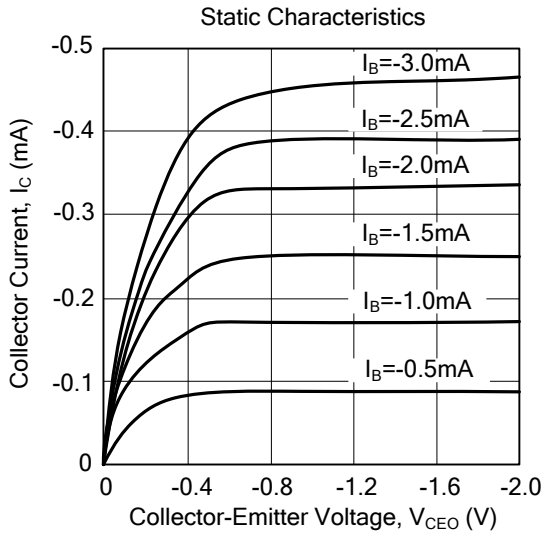

■ TYPICAL CHARACTERISTICS (Cont.)

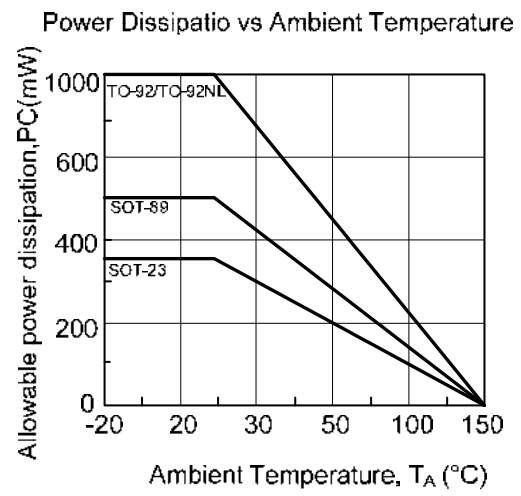
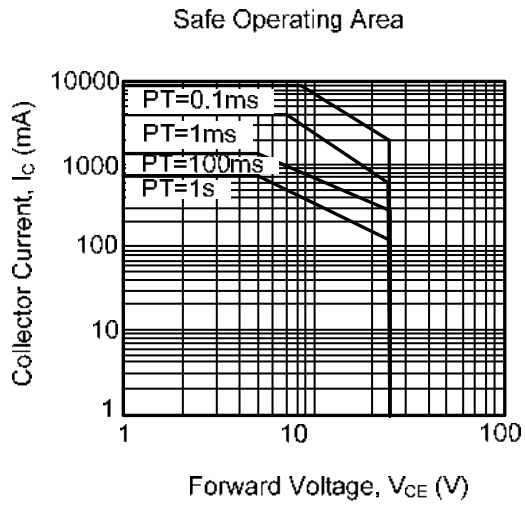

■ DIMENSION

单位 (UNIT) : mm

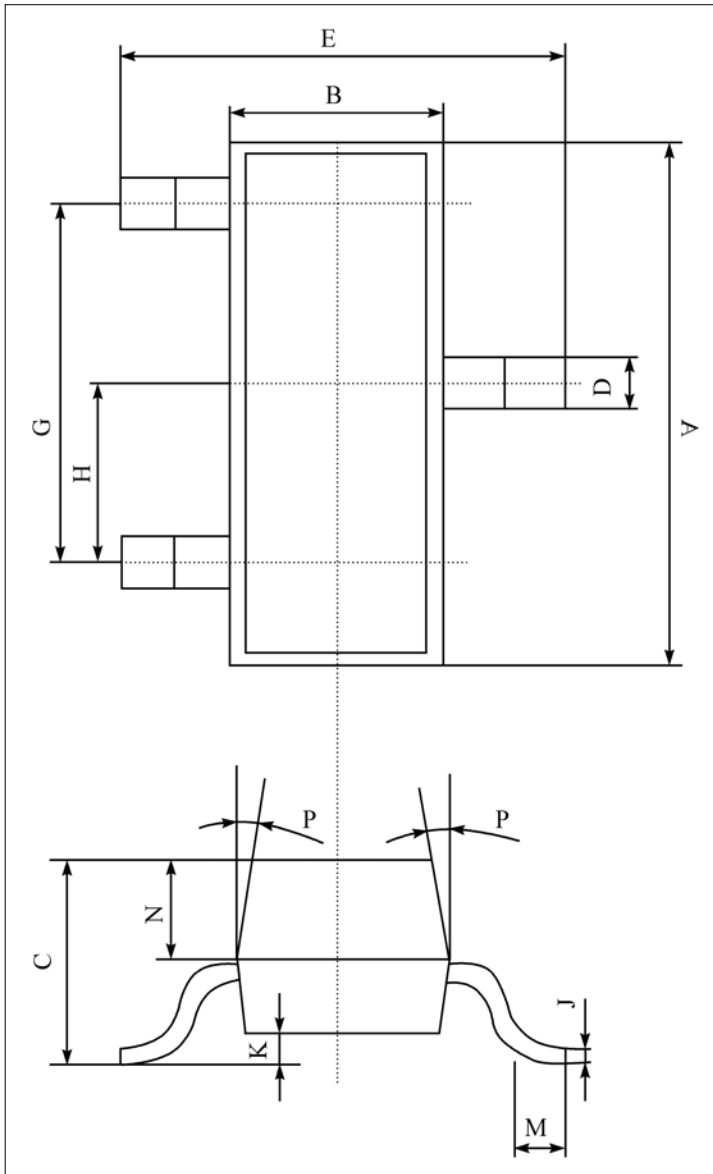

序号	数值及公差
A	2.90±0.10
B	1.30±0.10
C	1.00±0.10
D	0.40±0.10
E	2.40±0.20
G	1.90±0.10
H	0.95±0.05
J	0.13±0.05
K	0.00-0.10
M	≥0.20
N	0.60±0.10
P	7±2°

Packing
SOT-23 包装规格
SMD片式表面贴封装
包装方式: 载带卷盘包装
Tape & Reel, 3Kpcs/Reel
每卷数量3000只 (3Kpcs/Reel)
每盒数量45000只 (30Kpcs/BOX)
每箱数量180000只 (180Kpcs/Cartons)

SOT-23 Tape and reel

SOT-23 Embossed Carrier Tape

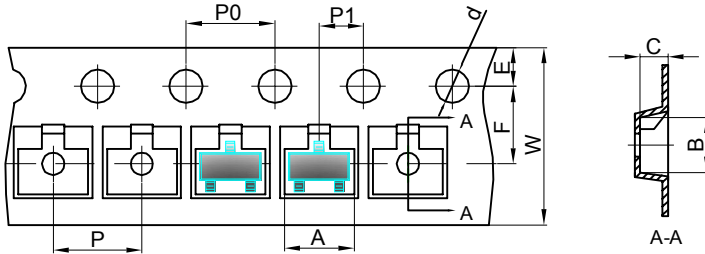

Dimensions are in millimeter										
Pkg type	A	B	C	d	E	F	P0	P	P1	W
SOT-23	3.15	2.77	1.22	Ø1.50	1.75	3.50	4.00	4.00	2.00	8.00

SOT-23 Tape Leader and Trailer

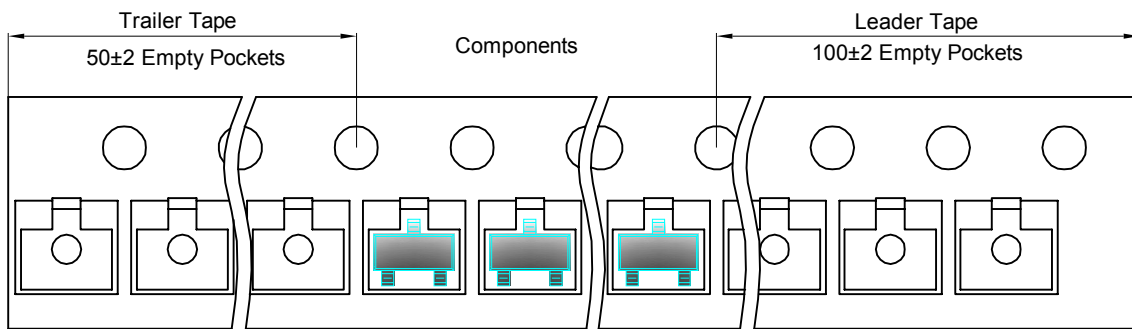

SOT-23 Reel

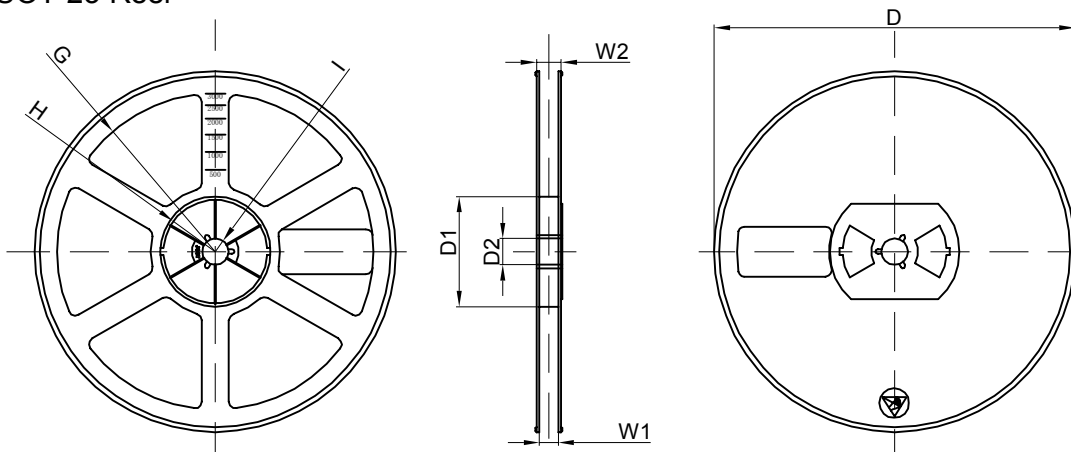

Dimensions are in millimeter								
Reel Option	D	D1	D2	G	H	I	W1	W2
7" Dia	Ø178.00	54.40	13.00	R78.00	R25.60	R6.50	9.50	12.30

REEL	Reel Size	Box	Box Size(mm)	Carton	Carton Size(mm)	G.W.(kg)
3000 pcs	7 inch	45,000 pcs	192×192×193	180,000 pcs	404×404×214	