

DC/DC Converter

VRA_ZP-6WR3 & VRB_ZP-6WR3 Series

6W isolated DC-DC converter in DIP package
Wide input and regulated dual/single output



FEATURES

- Wide 2:1 input voltage range
- High efficiency up to 88%
- No-load power consumption as low as 0.09W
- I/O isolation test voltage 1.5k VDC
- Operating ambient temperature range: -40°C to +85°C
- Meets CISPR32/EN55032 CLASS A, without extra components (except for 5VDC input)
- Input under-voltage protection, output short-circuit, over-current, over-voltage protection
- Industry standard pin-out

VRA_ZP-6WR3 & VRB_ZP-6WR3 series are isolated 6W DC-DC converter products with a wide range of voltage input of 4.5-9VDC, 9-18VDC, 18-36VDC, 36-75VDC isolation voltage of 1500VDC, input under-voltage protection, output short circuit, over-current, over-voltage protection and EMI meets CISPR32/EN55032 CLASS A without external components (except for 5VDC input); these products are widely used in fields such as industrial control, electric power, instruments and communication.

Selection Guide

Certification	Part No.	Input Voltage (VDC)		Output		Full Load Efficiency ^② (%) Min./Typ.	Capacitive Load ^③ (μF)Max.
		Nominal (Range)	Max. ^①	Voltage(VDC)	Current (mA) Max./Min.		
EN/BS EN	VRA0505ZP-6WR3	5 (4.5-9)	12	±5	±600/0	76/78	1000
	VRA0512ZP-6WR3			±12	±250/0	82/84	470
	VRA0515ZP-6WR3			±15	±200/0	82/84	220
	VRA0524ZP-6WR3			±24	±125/0	82/84	100
	VRB0505ZP-6WR3			5	1200/0	76/78	1000
	VRB0512ZP-6WR3			12	500/0	82/84	470
	VRB0515ZP-6WR3			15	400/0	82/84	220
	VRB0524ZP-6WR3			24	250/0	82/84	100
	VRA1205ZP-6WR3			12 (9-18)	20	±5	±600/0
	VRA1212ZP-6WR3	±12	±250/0			82/84	330
	VRA1215ZP-6WR3	±15	±200/0			83/85	220
	VRA1224ZP-6WR3	±24	±125/0			82/84	100
	VRB1203ZP-6WR3	3.3	1500/0			73/75	1800
	VRB1205ZP-6WR3	5	1200/0			78/80	1000
	VRB1212ZP-6WR3	12	500/0			82/84	470
	VRB1215ZP-6WR3	15	400/0			83/85	220
	VRB1224ZP-6WR3	24	250/0			83/85	100
	VRA2405ZP-6WR3	24 (18-36)	40	±5	±600/0	81/83	680
	VRA2412ZP-6WR3			±12	±250/0	84/86	330
	VRA2415ZP-6WR3			±15	±200/0	85/87	220
	VRA2424ZP-6WR3			±24	±125/0	83/85	100
	VRB2403ZP-6WR3			3.3	1500/0	76/78	1800
	VRB2405ZP-6WR3			5	1200/0	80/82	1000
	VRB2412ZP-6WR3			12	500/0	83/85	470
	VRB2415ZP-6WR3			15	400/0	84/86	220
	VRB2424ZP-6WR3			24	250/0	84/86	100
	VRA4805ZP-6WR3	48 (36-75)	80	±5	±600/0	81/83	680
	VRA4812ZP-6WR3			±12	±250/0	85/87	330
	VRA4815ZP-6WR3			±15	±200/0	83/85	220
	VRA4824ZP-6WR3			±24	±125/0	83/85	100

EN/BS EN	VRB4803ZP-6WR3	48 (36-75)	80	3.3	1500/0	77/79	1800
	VRB4805ZP-6WR3			5	1200/0	81/83	1000
	VRB4812ZP-6WR3			12	500/0	85/87	470
	VRB4815ZP-6WR3			15	400/0	86/88	220
	VRB4824ZP-6WR3			24	250/0	85/87	100

Notes:

- ① Exceeding the maximum input voltage may cause permanent damage;
- ② Efficiency is measured in nominal input voltage and rated output load;
- ③ The specified maximum capacitive load for Vo1 and Vo2 output is identical.

Input Specifications

Item	Operating Conditions		Min.	Typ.	Max.	Unit
Input Current (full load / no-load)	5VDC input	5V / ±5V output	--	1539/10	1579/30	mA
		Others	--	1429/10	1464/30	
	12VDC input	3.3V output	--	550/7	566/25	
		Others	--	607/7	641/25	
	24VDC input	3.3V output	--	265/7	272/25	
		Others	--	296/7	313/25	
	48VDC input	3.3V output	--	131/7	134/25	
		Others	--	147/7	155/25	
Reflected Ripple Current	5VDC input		--	50	--	
	Others		--	20	--	
Surge Voltage (1sec. max.)	5VDC input		-0.7	--	16	VDC
	12VDC input		-0.7	--	25	
	24VDC input		-0.7	--	50	
	48VDC input		-0.7	--	100	
Start-up Voltage	5VDC input		--	--	4.5	VDC
	12VDC input		--	--	9	
	24VDC input		--	--	18	
	48VDC input		--	--	36	
Input Under-voltage Protection	5VDC input		3	3.5	--	
	12VDC input		5.5	6.5	--	
	24VDC input		13	15	--	
	48VDC input		26	30	--	
Input Filter			Pi filter			
Hot Plug			Unavailable			

Output Specifications

Item	Operating Conditions		Min.	Typ.	Max.	Unit
Voltage Accuracy	5VDC input, 0%-100% load ^①	Vo1	--	±1	±2	
		Vo2	--	±1	±3	
	Others	Vo1	--	±1	±3	
		Vo2	--	±1	±3	
Linear Regulation	Input voltage variation from low to high at full load	Vo1	--	±0.2	±0.5	%
		Vo2	--	±0.5	±1	
Load Regulation	5VDC input, 0%-100% load	Vo1	--	--	±1	
		Vo2	--	--	±1.5	
	other input, 5%-100% load ^②	Vo1	--	±0.5	±1	
		Vo2	--	±0.5	±1.5	
Cross Regulation	Dual output, Vo1 load at 50%, Vo2 load at range of 10%-100%		--	--	±5	

Transient Recovery Time			--	300	500	μs
Transient Response Deviation	25% load step change, Nominal input voltage	3.3V/5V/±5V output	--	±5	±8	%
		Others	--	±3	±5	
Temperature Coefficient	Full load		--	--	±0.03	%/°C
Ripple & Noise ^③	20MHz bandwidth, 5%-100% load		--	--	100	mVp-p
Over-voltage Protection	Input voltage range		110	--	160	%Vo
Over-current Protection			110	140	190	%Io
Short-circuit Protection			Continuous, self-recovery			

Note: ① At 0%~5% load, the Max. output voltage accuracy of ±5VDC output converter is ±5%;
 ② load regulation for 0%-100% load is ±5%;
 ③ Under 0% -5% load conditions, ripple & noise does not exceed 5%Vo. The "parallel cable" method is used for ripple and noise test, please refer to DC-DC Converter Application Notes for specific information.

General Specifications

Item	Operating Conditions	Min.	Typ.	Max.	Unit
Isolation	Input-output Electric Strength Test for 1 minute with a leakage current of 1mA max.	1500	--	--	VDC
	Input/output-case Electric Strength Test for 1 minute with a leakage current of 1mA max.	1500	--	--	
Insulation Resistance	Input-output resistance at 500VDC	1000	--	--	MΩ
Isolation Capacitance	Input-output capacitance at 100kHz/0.1V	--	1000	--	pF
Operating Temperature	See Fig. 1	-40	--	85	°C
Storage Temperature		-55	--	+125	
Storage Humidity	Non-condensing	5	--	95	%RH
Pin Soldering Resistance Temperature	Soldering spot is 1.5mm away from case for 10 seconds	--	--	300	°C
Vibration		10-150Hz, 5G, 30 Min. along X, Y and Z			
Switching Frequency *	PWM mode	--	300	--	kHz
MTBF	MIL-HDBK-217F@25°C	1000	--	--	k hours

Note: * Switching frequency is measured at full load. The module reduces the switching frequency for light load (below 50%) efficiency improvement.

Mechanical Specifications

Case Material	Aluminum alloy
Dimensions	32.00 x 20.00 x 10.80mm
Weight	12.0g(Typ.)
Cooling Method	Free air convection

Electromagnetic Compatibility (EMC)

Emissions	CE	5VDC input	CISPR32/EN55032	CLASS B (see Fig.3-② for recommended circuit)	
		Others	CISPR32/EN55032	CLASS A (without external components)/ CLASS B (see Fig.4-② for recommended circuit)	
	RE	5VDC input	CISPR32/EN55032	CLASS B (see Fig.3-② for recommended circuit)	
		Others	CISPR32/EN55032	CLASS A (without external components)/ CLASS B (see Fig.4-② for recommended circuit)	
Immunity	ESD		IEC/EN61000-4-2	Contact ±4kV	perf. Criteria B
	RS		IEC/EN61000-4-3	10V/m	perf. Criteria A
	EFT	5VDC input	IEC/EN61000-4-4	±2kV (see Fig.3-① for recommended circuit)	perf. Criteria B
		Others	IEC/EN61000-4-4	±2kV (see Fig.4-① for recommended circuit)	perf. Criteria B
	Surge	5VDC input	IEC/EN61000-4-5	line to line ±2kV (see Fig.3-① for recommended circuit)	perf. Criteria B
		Others	IEC/EN61000-4-5	line to line ±2kV (see Fig.4-① for recommended circuit)	perf. Criteria B
CS		IEC/EN61000-4-6	3 Vr.m.s	perf. Criteria A	

Typical Characteristic Curves

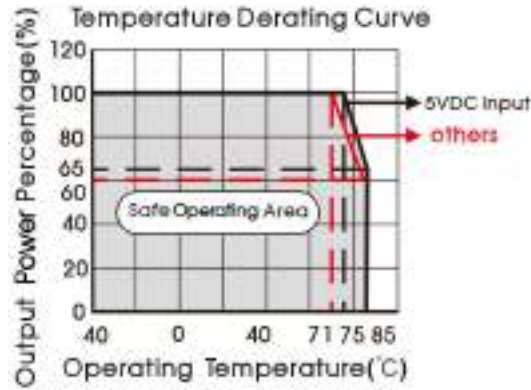
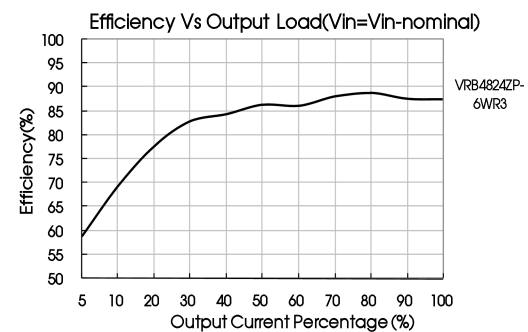
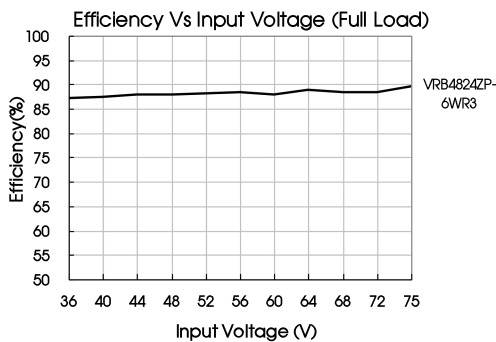
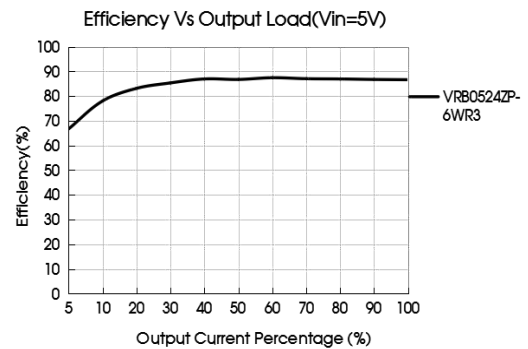
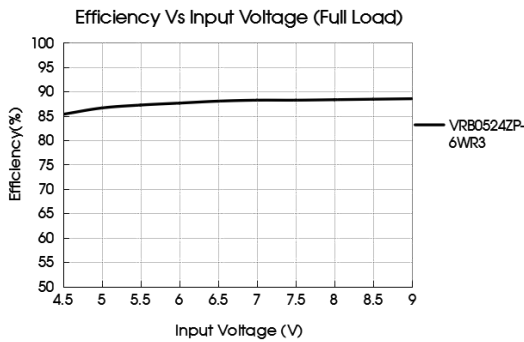
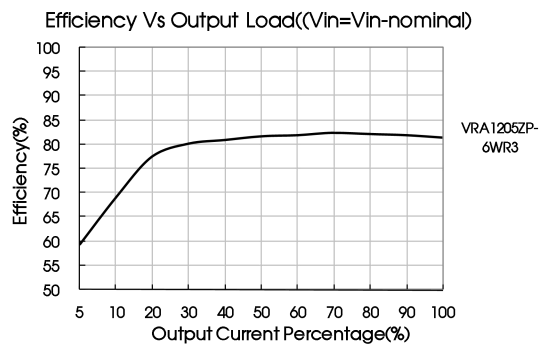
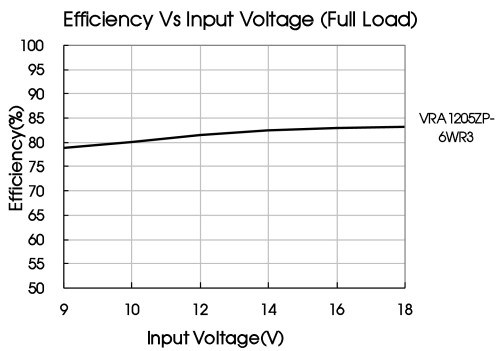
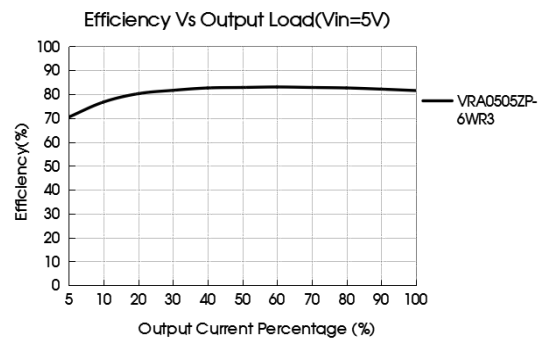
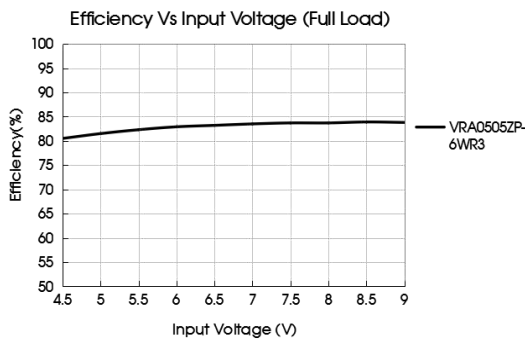

Fig. 1



Design Reference

1. Typical application

All the DC/DC converters of this series are tested before delivery using the recommended circuit shown in Fig. 2. Input and/or output ripple can be further reduced by appropriately increasing the input & output capacitor values C_{in} and C_{out} and/or by selecting capacitors with a low ESR (equivalent series resistance). Also make sure that the capacitance is not exceeding the specified max. capacitive load value of the product.

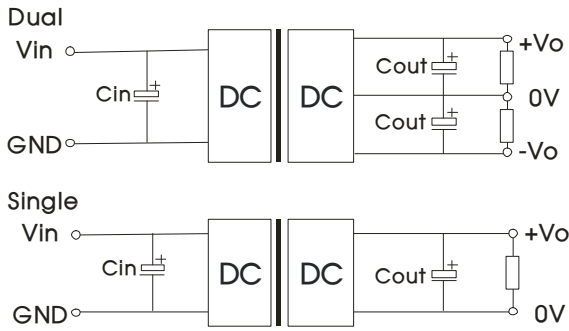

Fig. 2

Vin(VDC)	Vout(VDC)	Cin	Cout
5	5/±5	100µF/16V	10µF/16V
	12/15/±12/±15		10µF/25V
	24/±24		10µF/50V
12	3.3/5/±5	100µF35V	10µF/16V
	12/15/±12/±15		10µF/25V
	24/±24		10µF/50V
24	3.3/5/±5	100µF/50V	10µF/16V
	12/15/±12/±15		10µF/25V
	24/±24		10µF/50V
48	3.3/5/±5	10µF - 47µF/100V	10µF/16V
	12/15/±12/±15		10µF/25V
	24/±24		10µF/50V

2. EMC compliance circuit

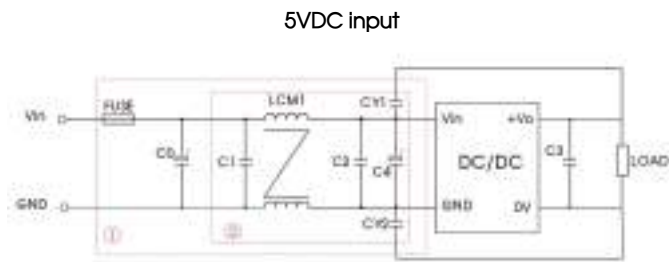

Fig. 3

Notes: For EMC tests we use Part ① in Fig. 3 for immunity and part ② for emissions test. Selecting based on needs.

Parameter description:

Model	Vin: 5VDC
FUSE	Select fuse value according to actual input current
C0	2200µF/35V
C1/C2	4.7µF/50V
C3	Refer to the Cout in Fig.2
C4	100µF/35V
LCM1	2.2mH, recommended to use MORNSUN's FL2D-30-222
CY1/CY2	2.2nF/2kV

12VDC/24VDC/48VDC input

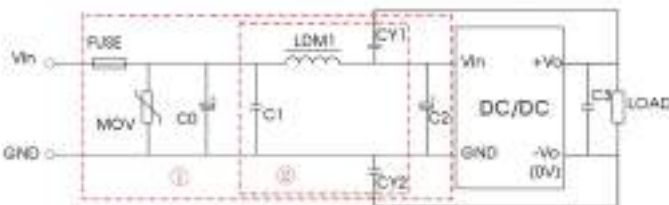

Fig. 4

Notes: For EMC tests we use Part ① in Fig. 4 for immunity and part ② for emissions test. Selecting based on needs.

Parameter description:

Model	Vin: 12VDC	Vin: 24VDC	Vin: 48VDC
FUSE	Select fuse value according to actual input current		
MOV	S14K20	S20K30	S14K60
C0	1000µF/35V	1000µF/50V	680µF/100V
C2	100µF/35V	100µF/50V	100µF/100V
C1	1µF/50V		1µF/100V
C3	Refer to the Cout in Fig.2		
LDM1	4.7µH		
CY1, CY2	1nF/2kV		

3. The products do not support parallel connection of their output

4. For additional information please refer to DC-DC converter application notes on www.mornsun-power.com

Dimensions and Recommended Layout

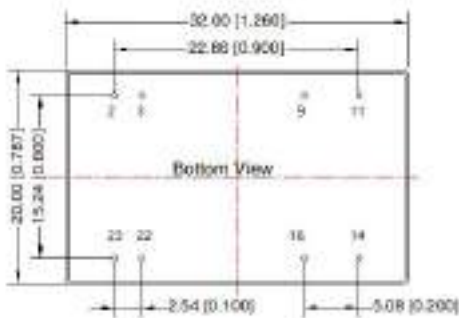
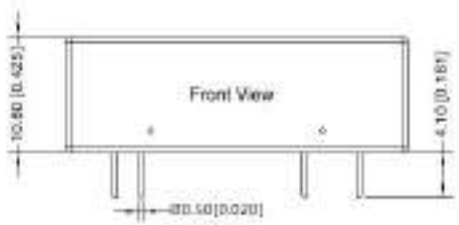

Note:
Unit: mm(Inch)
Pin diameter tolerance: ± 0.10 (± 0.004)
General tolerances: ± 0.50 (± 0.020)

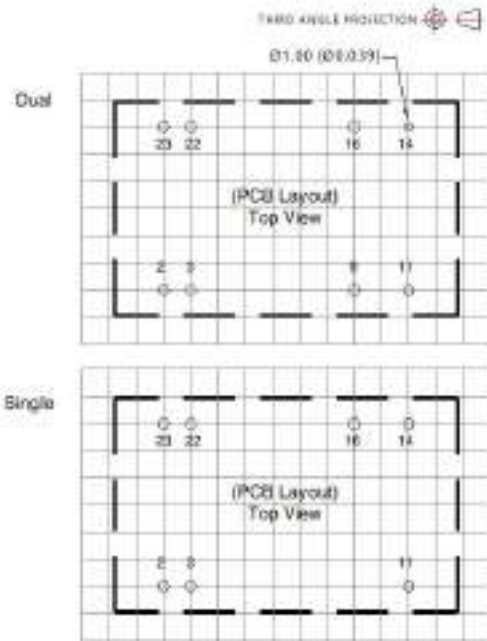

Note: Grid 2.54*2.54mm

Pin-Out		
Pin	Single	Dual
23	GND	GND
9*	No Pin	0V
11	NC	-Vo
14	+Vo	+Vo
16	0V	0V
22,23	Vin	Vin

* Note: 5V input, product without 9th pin
NC: Pin to be isolated from circuit

Notes:

- For additional information on Product Packaging please refer to www.mornsun-power.com. Packaging bag number: 58210008;
- The maximum capacitive load offered were tested at input voltage range and full load;
- Unless otherwise specified, parameters in this datasheet were measured under the conditions of $T_a=25^{\circ}\text{C}$, humidity<75%RH with nominal input voltage and rated output load;
- All index testing methods in this datasheet are based on company corporate standards;
- We can provide product customization service, please contact our technicians directly for specific information;
- Products are related to laws and regulations: see "Features" and "EMC";
- Our products shall be classified according to ISO14001 and related environmental laws and regulations, and shall be handled by qualified units.

Mornsun Guangzhou Science & Technology Co., Ltd.

Address: No. 5, Kehui St. 1, Kehui Development Center, Science Ave., Guangzhou Science City, Huangpu District, Guangzhou, P. R. China
Tel: 86-20-38601850 Fax: 86-20-38601272 E-mail: info@mornsun.cn www.mornsun-power.com