

15W isolated DC-DC converter DIP package  
Ultra-wide input and regulated single output



### FEATURES

- Ultra-wide 4:1 input voltage range
- High efficiency up to 91%
- I/O isolation test voltage 1.5k VDC
- Input under-voltage protection, output short-circuit, over-current, over-voltage protection
- Operating ambient temperature range -40°C to +105°C
- CISPR32/EN55032 CLASS A EMI compliant without external components
- Input reverse polarity protection available with chassis(A2S) or 35mm DIN-rail mounting(A4S) version
- Industry standard pin-out
- Meets EN50155 railway standard



*URB\_YMD-15WR3 series of isolated DC-DC converter products feature an ultra-wide 4:1 input voltage with efficiencies of up to 91%, 1500VDC input to output isolation, an operating ambient temperature range of -40 °C to +105 °C, input under-voltage protection, output short-circuit, over-current, over-voltage protection, CISPR32/EN55032 CLASS A EMI compliant without external components, which makes them widely used in industrial control, electric power, instruments communication and railway applications. Optional packages are offered for chassis or DIN-rail mounting (A2S, A4S), adding additional input reverse polarity protection.*

### Selection Guide

Certification	Part No. <sup>①</sup>	Input Voltage (VDC)		Output		Full Load Efficiency <sup>④</sup> (%) Min./Typ.	Capacitive Load (μF)Max.
		Nominal <sup>②</sup> (Range)	Max. <sup>③</sup>	Voltage (VDC)	Current(mA) Max./Min.		
UL/EN/BS EN/IEC	URB2403YMD-15WR3	24 (9-36)	40	3.3	4000/0	86/88	4700
	URB2405YMD-15WR3			5	3000/0	88/90	4700
	URB2412YMD-15WR3			12	1250/0	88/90	1000
	URB2415YMD-15WR3			15	1000/0	89/91	820
	URB2424YMD-15WR3			24	625/0	89/91	270
	URB4803YMD-15WR3	48 (18-75)	80	3.3	4000/0	86/88	4700
	URB4805YMD-15WR3			5	3000/0	88/90	4700
	URB4812YMD-15WR3			12	1250/0	89/91	1000
	URB4815YMD-15WR3			15	1000/0	89/91	820
	URB4824YMD-15WR3			24	625/0	89/91	270

Notes:  
<sup>①</sup> Use "H" suffix for heat sink mounting, "A2S" suffix for chassis mounting and "A4S" suffix for DIN-Rail mounting. We recommend to choose modules with a heat sink for enhanced heat dissipation and applications with extreme temperature requirements;  
<sup>②</sup> The A2S and A4S Model's start-up and minimum input voltages are increased by 1VDC due to the input reverse polarity protection circuit;  
<sup>③</sup> Exceeding the maximum input voltage may cause permanent damage;  
<sup>④</sup> Efficiency is measured at nominal input voltage and rated output load; efficiencies for A2S and A4S model is decreased by 2% due to the input reverse polarity protection circuit.

### Input Specifications

Item	Operating Conditions	Min.	Typ.	Max.	Unit	
Input Current (full load / no-load)	24VDC nominal input series, nominal input voltage	3.3V output	--	625/30	640/50	mA
		5V output	--	694/30	710/50	
		12V output	--	694/6	710/15	
		15V output	--	687/6	703/15	
		24V output	--	687/10	703/20	
	48VDC nominal input series, nominal input voltage	3.3V output	--	313/15	320/30	
		5V output	--	348/15	356/30	
		12V output	--	344/3	352/11	
		15V output	--	344/3	352/11	
		24V output	--	344/4	352/11	
Reflected Ripple Current	Nominal input voltage	--	30	--		
Surge Voltage (1sec. max.)	24VDC nominal input series	-0.7	--	50	VDC	
	48VDC nominal input series	-0.7	--	100		
Start-up Voltage	24VDC nominal input series	--	--	9		
	48VDC nominal input series	--	--	18		
Input under-voltage protection	24VDC nominal input series	5.5	6.5	--		
	48VDC nominal input series	12	15.5	--		
Start-up Time	Nominal input voltage & constant resistance load	--	10	--	ms	
Input Filter		PI filter				
Hot Plug		Unavailable				
Ctrl *	Module on	Ctrl pin open or pulled high (TTL 3.5-12VDC)				
	Module off	Ctrl pin pulled low to GND (0-1.2VDC)				
	Input current when off	--	2	7	mA	

Note: \*The Ctrl pin voltage is referenced to input GND.

### Output Specifications

Item	Operating Conditions	Min.	Typ.	Max.	Unit
Voltage Accuracy	0%-100% load	--	±1	±3	%
Linear Regulation	Input voltage variation from low to high at full load	--	±0.2	±0.5	
Load Regulation	5%-100% load	--	±0.5	±1	
Transient Recovery Time	25% load step change, nominal input voltage	--	300	500	µs
Transient Response Deviation		3.3, 5V output	--	±3	±7
		Others	--	±3	±5
Temperature Coefficient	Full load	--	--	±0.03	%/°C
Ripple & Noise*	20MHz bandwidth, 100% load	--	50	100	mV p-p
Trim	Input voltage range	90	--	110	%Vo
Over-voltage Protection		110	--	160	
Over-current Protection		110	150	190	%Io
Short circuit Protection		Continuous, self-recovery			

Note: \*Under 0% -5% load conditions, ripple & noise does not exceed 5%Vo. The "parallel cable" method is used for Ripple and Noise test, please refer to DC-DC Converter Application Notes for specific information.

### General Specifications

Item	Operating Conditions	Min.	Typ.	Max.	Unit
Isolation	Input-output Electric Strength Test for 1 minute with a leakage current of 1mA max.	1500	--	--	VDC
	Input/output-case Electric Strength Test for 1 minute with a leakage current of 1mA max.	1000	--	--	

Insulation Resistance	Input-output resistance at 500VDC	1000	--	--	M $\Omega$
Isolation Capacitance	Input-output capacitance at 100kHz/0.1V	--	2000	--	pF
Operating Temperature	See Fig. 1	3.3, 5V output	-40	--	+95
		Others	-40	--	+105
Storage Temperature		-55	--	+125	°C
Storage Humidity	Non-condensing	5	--	95	%RH
Pin Soldering Resistance Temperature	Soldering spot is 1.5mm away from case for 10 seconds	--	--	+300	°C
Vibration		IEC/EN61373 - Category 1, Grade B			
Switching Frequency *	PWM mode	3.3V, 5V output	--	300	--
		Others	--	270	--
MTBF	MIL-HDBK-217F@25°C	1000	--	--	k hours

Note: \*Switching frequency is measured at full load. The module reduces the switching frequency for light load (below 50%) efficiency improvement.

### Mechanical Specifications

Case Material	Aluminum alloy				
Dimensions	Horizontal package(without heat sink)		25.40 x 25.40 x 11.70 mm		
	Horizontal package(with heat sink)		25.40 x 25.40 x 16.20 mm		
	A2S chassis package (without heat sink)		76.00 x 31.50 x 21.20 mm		
	A2S chassis package(with heat sink)		76.00 x 31.50 x 25.20 mm		
	A4S Din-rail package(without heat sink)		76.00 x 31.50 x 25.80 mm		
	A4S Din-rail package(with heat sink)		76.00 x 31.50 x 29.80 mm		
Weight	Without heat sink	Horizontal package/A2S chassis package/A4S rail package	15.0g/38.0g/58.0g (Typ.)		
	With heat sink	Horizontal package/A2S chassis package/A4S rail package	19.0g/42.0g/62.0g (Typ.)		
Cooling method	Free air convection				

### Electromagnetic Compatibility (EMC)

Emissions	CE	CISPR32/EN55032	CLASS A (without external components)/ CLASS B (see Fig.3-② for recommended circuit)		
	RE	CISPR32/EN55032	CLASS A (without external components)/ CLASS B (see Fig.3-② for recommended circuit)		
Immunity	ESD	IEC/EN61000-4-2	Contact $\pm 6$ kV, Air $\pm 8$ kV		perf. Criteria B
	RS	IEC/EN61000-4-3	10V/m		perf. Criteria A
	EFT	IEC/EN61000-4-4	$\pm 2$ kV (see Fig.3-① for recommended circuit)		perf. Criteria A
	Surge	IEC/EN61000-4-5	line to line $\pm 2$ kV (see Fig.3-① for recommended circuit)		perf. Criteria B
	CS	IEC/EN61000-4-6	3 Vr.m.s		perf. Criteria A

### Electromagnetic Compatibility (EMC) (EN50155)

Emissions	CE	EN50121-3-2	150kHz-500kHz	99dBuV	(see Fig.3-② for recommended circuit)	
		EN55016-2-1	500kHz-30MHz	93dBuV	(see Fig.3-② for recommended circuit)	
Immunity	RE	EN50121-3-2	30MHz-230MHz	40dBuV/m at 10m	(see Fig.3-② for recommended circuit)	
		EN55016-2-1	230MHz-1GHz	47dBuV/m at 10m	(see Fig.3-② for recommended circuit)	
		ESD	EN50121-3-2	Contact $\pm 6$ kV/Air $\pm 8$ kV		perf. Criteria A
		RS	EN50121-3-2	20V/m		perf. Criteria A
		EFT	EN50121-3-2	$\pm 2$ kV	5/50ns	5kHz
Immunity	Surge	EN50121-3-2	line to line $\pm 1$ kV (42 $\Omega$ , 0.5 $\mu$ F)		(see Fig.3-① for recommended circuit)	
		CS	EN50121-3-2	0.15MHz-80MHz	10V r.m.s	perf. Criteria A

Typical Characteristic Curves

Nominal input voltage, 12V, 15V, 24V output

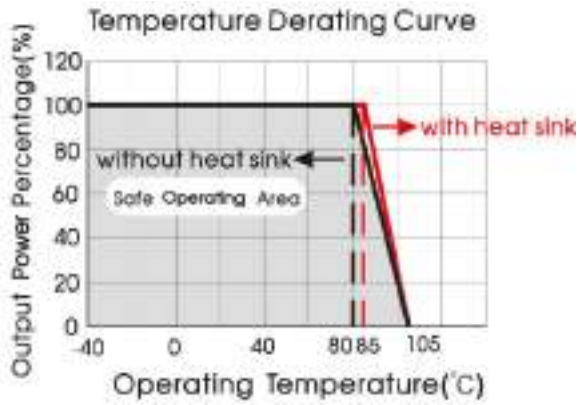

Nominal input voltage, 3.3V, 5V output

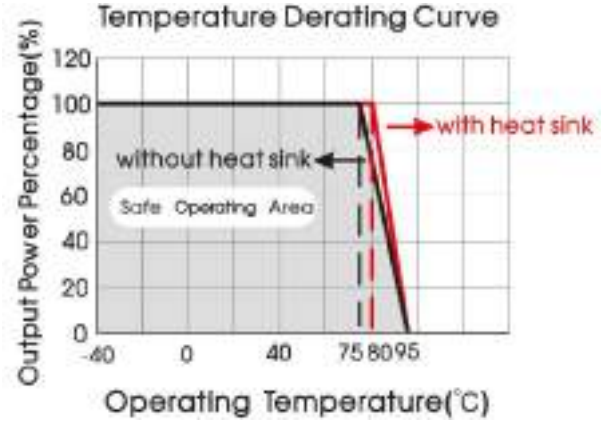
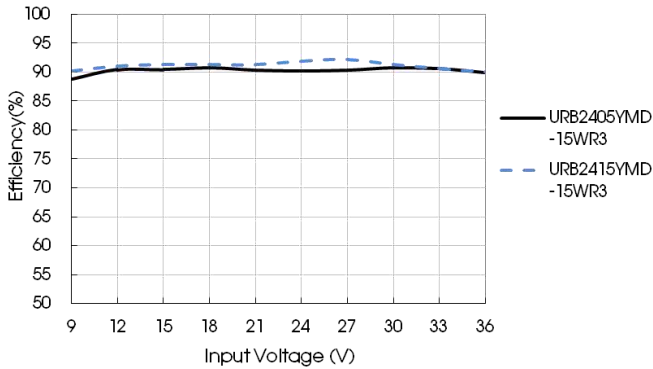
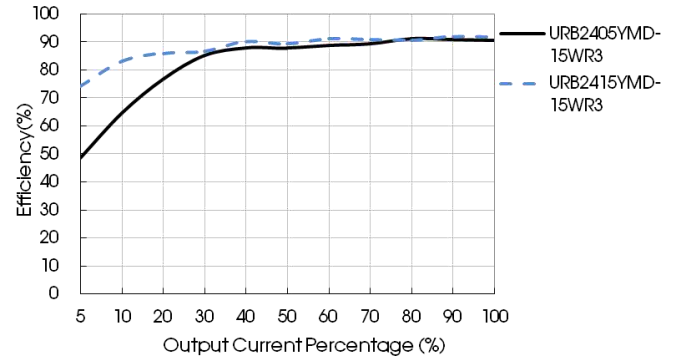

Fig. 1

Efficiency Vs Input Voltage (Full Load)



Efficiency Vs Output Load (Vin=24V)



Efficiency Vs Input Voltage (Full Load)

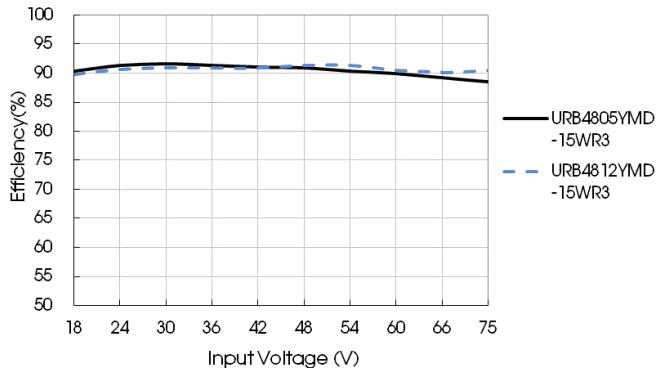

Efficiency Vs Output Load (Vin=48V)

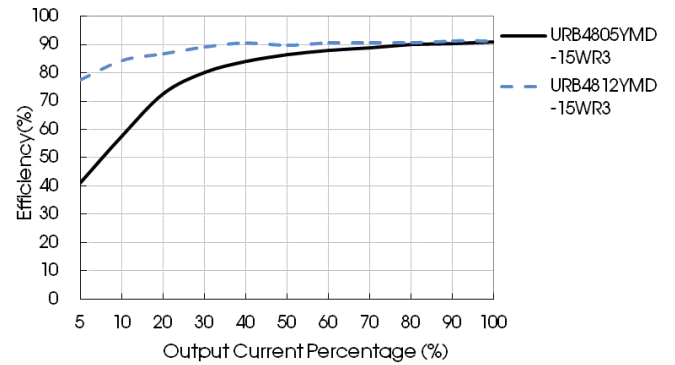

Design Reference

1. Typical application

All DC-DC converters of this series are tested before delivery using the recommended circuit shown in Fig. 2.

Input and/or output ripple can be further reduced by appropriately increasing the input & output capacitor values  $C_{in}$  and  $C_{out}$  and/or by selecting capacitors with a low ESR (equivalent series resistance). Also make sure that the capacitance is not exceeding the specified max. capacitive load value of the product.



Fig. 2

Vin (VDC)	Vout (VDC)	Cin	Cout
24	3.3/5	100µF/50V	100µF/16V
	12/15		100µF/25V
	24		47µF/50V
48	3.3/5	100µF/100V	100µF/16V
	12/15		100µF/25V
	24		47µF/50V

2. EMC compliance circuit

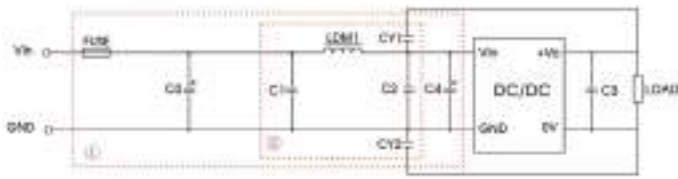

Fig. 3

Notes: We use Part ① in Fig. 3 for Immunity tests and Part ② for Emissions test. Selecting based on needs.

Parameter description:

Model	Vin: 24VDC	Vin: 48VDC
FUSE	Select fuse value according to actual input current	
C0, C4	330μF/50V	330μF/100V
C1, C2	4.7μF/50V	4.7μF/100V
C3	Refer to the Cout in Fig.2	
LDM1	2.2μH/4A	2.2μH/2A
CY1, CY2	1nF/2kV	

3. Trim Function for Output Voltage Adjustment (open if unused)

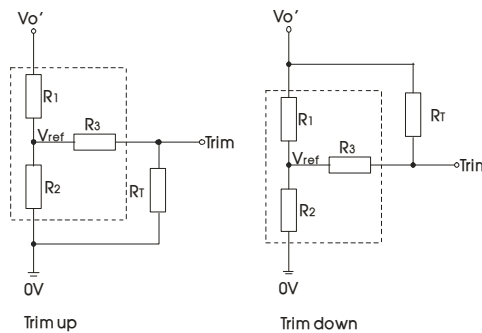

TRIM resistor connection (dashed line shows internal resistor network)

Calculating Trim resistor values:

$$\begin{aligned} \text{up: } R_T &= \frac{aR_2}{R_2 - a} - R_3 & a &= \frac{V_{ref}}{V_{o'} - V_{ref}} \cdot R_1 \\ \text{down: } R_T &= \frac{aR_1}{R_1 - a} - R_3 & a &= \frac{V_{o'} - V_{ref}}{V_{ref}} \cdot R_2 \end{aligned}$$

$R_T$  is Trim resistance  
 $a$  is a self-defined parameter, with no real meaning.

Vout(V)	R1(kΩ)	R2(kΩ)	R3(kΩ)	Vref(V)
3.3	4.801	2.87	15	1.24
5	2.894	2.87	10	2.5
12	11.000	2.87	17.4	2.5
15	14.494	2.87	17.4	2.5
24	24.872	2.87	20	2.5

4. The products do not support parallel connection of their output

5. For additional information please refer to DC-DC converter application notes on [www.mornsun-power.com](http://www.mornsun-power.com)

Horizontal Package (without heat sink) Dimensions and Recommended Layout

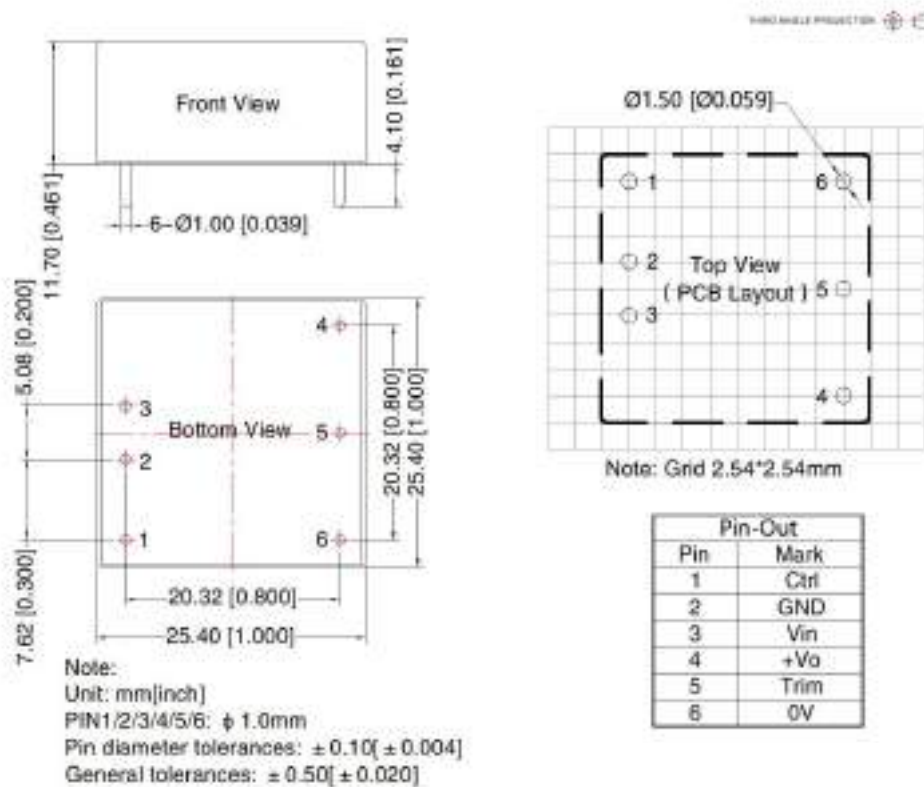

Horizontal Package (with heat sink) Dimensions

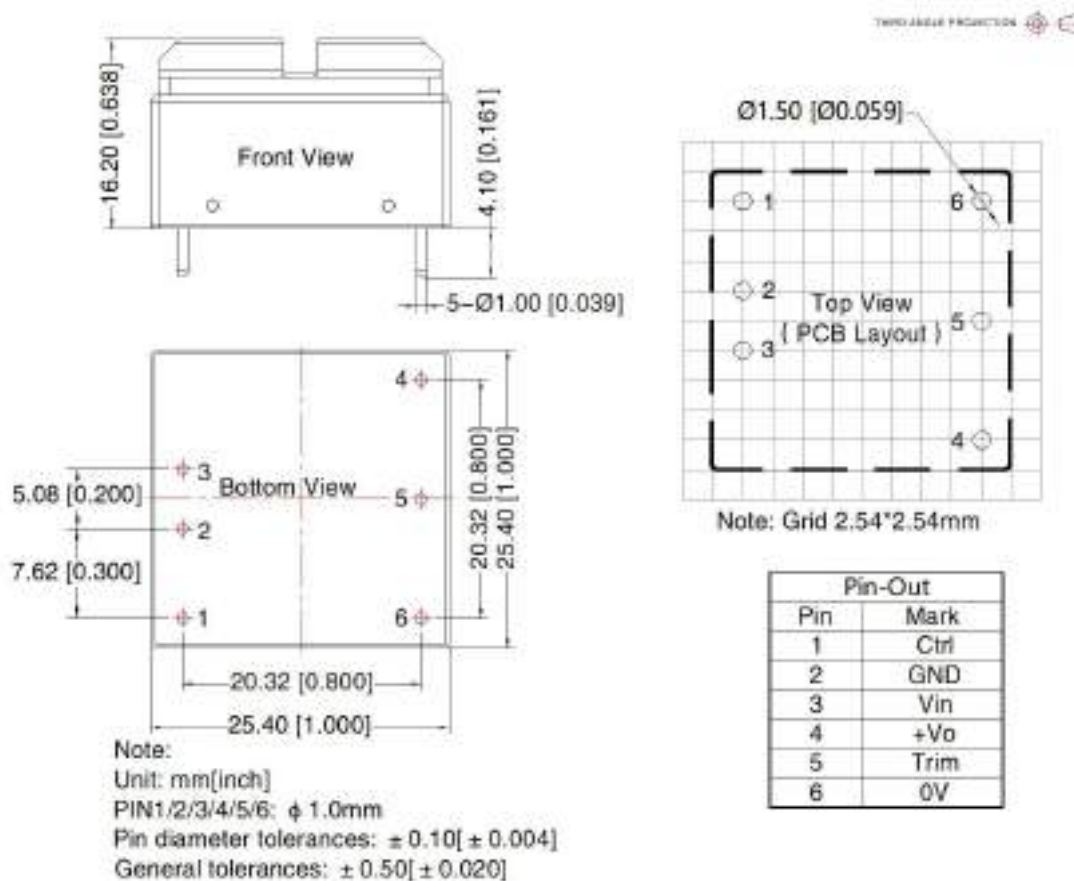

URB\_YMD-15WR3A2S Dimensions

THIRD ANGLE PROJECTION

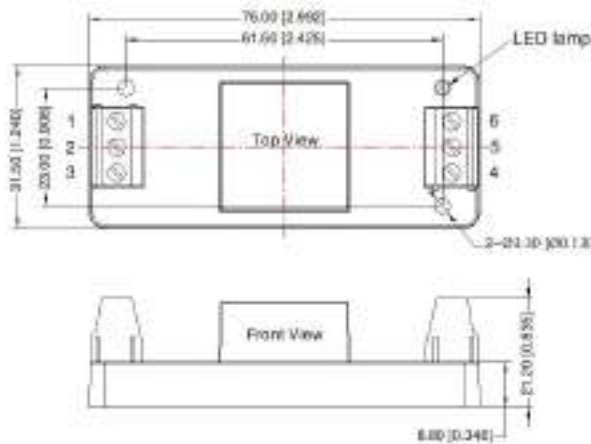

Pin-Out						
Pin	1	2	3	4	5	6
Mark	Ctrl	GND	Vin	+Vo	Trim	0V

Note:  
Unit: mm[inch]  
Wire range: 24-12 AWG  
Tightening torque: Max 0.4 N · m  
General tolerances: ± 1.00 [± 0.039]

URB\_YMD-15WHR3A2S (with heat sink) Dimensions

THIRD ANGLE PROJECTION

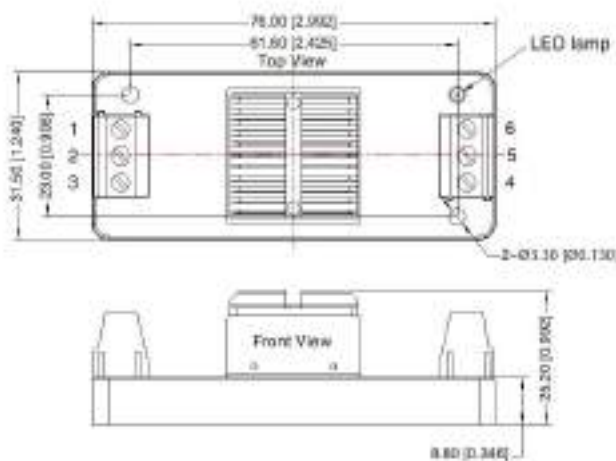

Pin-Out						
Pin	1	2	3	4	5	6
Mark	Ctrl	GND	Vin	+Vo	Trim	0V

Note:  
Unit: mm[inch]  
Wire range: 24-12 AWG  
Tightening torque: Max 0.4 N · m  
General tolerances: ± 1.00 [± 0.039]

URB\_YMD-15WR3A4S Dimensions

THIRD ANGLE PROJECTION

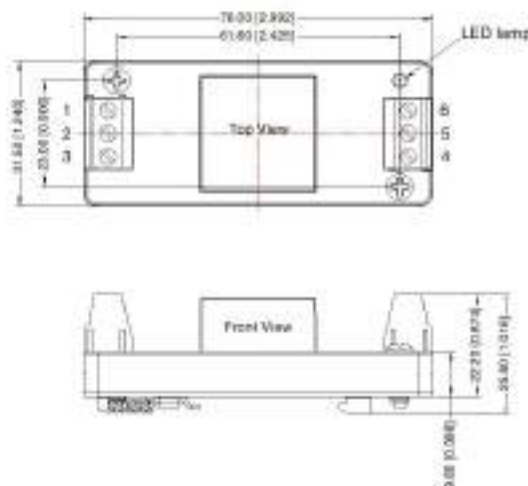

Pin-Out						
Pin	1	2	3	4	5	6
Mark	Ctrl	GND	Vin	+Vo	Trim	0V

Note:  
Unit: mm[inch]  
Mounting rail: TS35  
Wire range: 24-12 AWG  
Tightening torque: Max 0.4 N · m  
General tolerances: ± 1.00 [± 0.039]

URB\_YMD-15WHR3A4S(with heat sink) Dimensions

THIRD ANGLE PROJECTION 

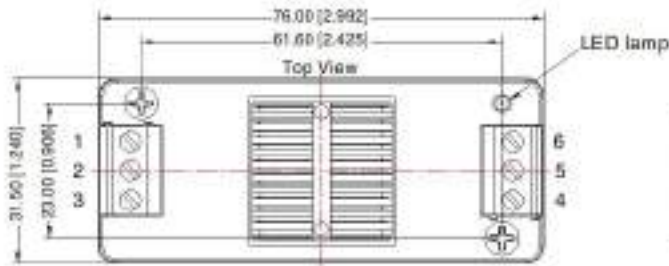

Pin-Out						
Pin	1	2	3	4	5	6
Mark	Ctrl	GND	Vin	+Vo	Trim	0V

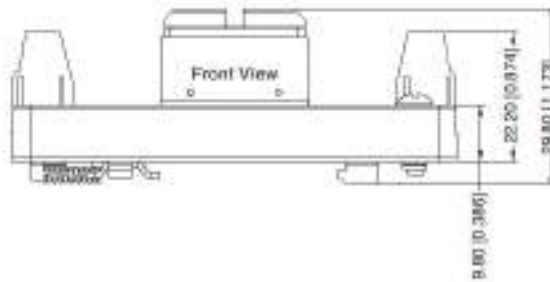

Note:  
Unit: mm[inch]  
Mounting rail: TS35  
Wire range: 24-12 AWG  
Tightening torque: Max 0.4 N · m  
General tolerances: ± 1.00[± 0.039]

- Note:
1. For additional information on Product Packaging please refer to [www.mornsun-power.com](http://www.mornsun-power.com). Packaging bag number: 58210003 (DIP), 58200048 (with heat sink), 58220022(A2S/A4S package);
  2. If the product is not operated within the required load range, the product performance cannot be guaranteed to comply with all parameters in the datasheet;
  3. The maximum capacitive load offered were tested at input voltage range and full load;
  4. Unless otherwise specified, parameters in this datasheet were measured under the conditions of  $T_a=25^{\circ}\text{C}$ , humidity<75%RH with nominal input voltage and rated output load;
  5. All index testing methods in this datasheet are based on company corporate standards;
  6. We can provide product customization service, please contact our technicians directly for specific information;
  7. Products are related to laws and regulations: see "Features" and "EMC";
  8. Our products shall be classified according to ISO14001 and related environmental laws and regulations, and shall be handled by qualified units.

Mornsun Guangzhou Science & Technology Co., Ltd.

Address: No. 5, Kehui St. 1, Kehui Development Center, Science Ave., Guangzhou Science City, Huangpu District, Guangzhou, P. R. China  
Tel: 86-20-38601850 Fax: 86-20-38601272 E-mail: [info@mornsun.cn](mailto:info@mornsun.cn) [www.mornsun-power.com](http://www.mornsun-power.com)