

LoRa-E5

LoRa Wireless Module - Powered by STM32WE5

Datasheet

V1.0

Content

Content.....	2
1 Introduction.....	- 3 -
1.1 Feature	3
2 Description	5
2.1 Pin definition	5
3 Electrical characteristics	6
3.1 Extreme working conditions	6
3.2 Normal working conditions.....	7
3.3 Module specifications	7
4 Typical RF performance test.....	8
4.1 LoRa-E5-LF Performance Testing	8
4.2 LoRa-E5-HF Performance Testing	11
5 Application information.....	14
5.1 Package information.....	14
5.2 External interface of the module	15
5.3 Reference design based on LoRa-E5 module.....	15
6 LoRaWAN® application information.....	16
6.1 LoRaWAN® application	16
6.2 Design LoRaWAN® wireless sensor based on LoRa-E5.....	16
7 Ordering information	17
8 Reversion	17

1 Introduction

LoRa-E5 is a low-cost, ultra-low power, ultra-small size LoRaWAN[®] module designed by Seeed Technology Co., Ltd. The module uses ST system-level package chip STM32WLE5JC, embedded high-performance LoRa[®] chip SX126X and ultra-low power Consumption of MCU. The target application of this module is wireless sensor networks and other Internet of Things devices, especially battery-powered low power consumption and long-distance occasions.

This specification mainly describes the hardware information, hardware performance and application information of the module.

LoRa-E5 LoRaWAN[®] module is mainly suitable for long-distance, ultra-low-power applications such as wireless meter reading, sensor networks, and other low-power wide-area IoT scenarios.

1.1 Feature

- Low power consumption: as low as 2.1uA sleep current (WOR mode)
- low cost:
- Small size: 12mm X 12mm * 2.5mm 28 pins SMT
- High performance:
 - ✓ LoRa-E5-LF
 - ✓ TXOP=10dBm@434MHz
 - ✓ TXOP=22dBm@470MHz
 - ✓ LoRa-E5-HF:
 - ✓ TXOP=22dBm@868/915MHz
 - ✓ -136.5dBm sensitivity for SF12 with 125KHz BW
- 158dB link budget, suitable for long distance
- interface
 - ✓ USART
 - ✓ I2C
 - ✓ ADC
 - ✓ SWD
- Embedded LoRaWAN[®] protocol, AT command, support global LoRaWAN[®] frequency plan
 - ✓ EU868
 - ✓ US915 and US915 Hybrid
 - ✓ CN779
 - ✓ AU915
 - ✓ CN470 and CN470 Prequel
 - ✓ AS923
 - ✓ KR920
 - ✓ IN865

This product specification includes a detailed description of the LoRa-E5 module's performance and functions. For the latest firmware, product updates or errata, please contact Seeedstudio.

2 Description

LoRa-E5 is embedded with high-performance STM32WLE5JC, which is very suitable for the design of various IoT nodes.

Based on the development of the multi-mode high-performance SX126X chip, the LoRa-E5 module supports (G)FSK mode and LoRa[®]. 62.5kHz, 125kHz, 250kHz and 500kHz bandwidth can be used in LoRa[®] mode.

Based on the powerful functions and rich peripherals of STM32WLE5JC, the module provides UART, I2C, SPI, ADC and GPIOs for users to choose according to the application. If you need to upgrade the built-in AT command firmware, please use the two-wire interface (UART) to complete the programming based on the boot mode; and customers can develop the software based on the internal MCU of the module to complete the program erasure and programming through SWD.

LoRa-E5 currently contains two sub-models, LoRa-E5-LF (Single-core STM32WLE5JC + SX126X) and LoRa-E5-HF (Single-core STM32WLE5JC + SX126X), LoRa-E5-LF supports 22dBm @ LF band (470MHz); 10dBm @ LF band (434MHz); LoRa-E5-HF supports 22dBm @ HF band (868 / 915MHz).

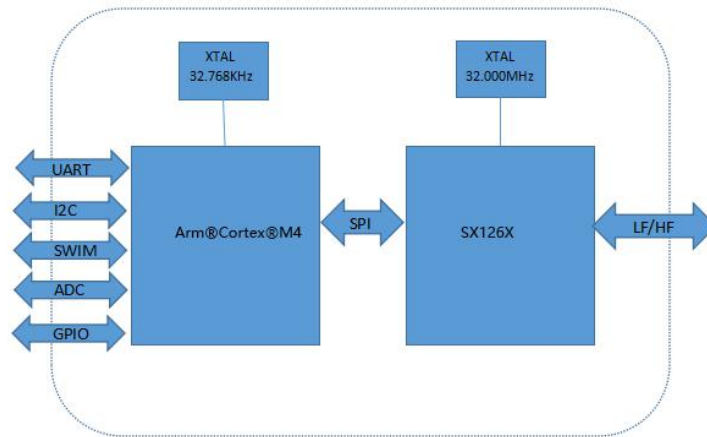

Figure 1 LoRa-E5 Schematic diagram

2.1 Pin definition

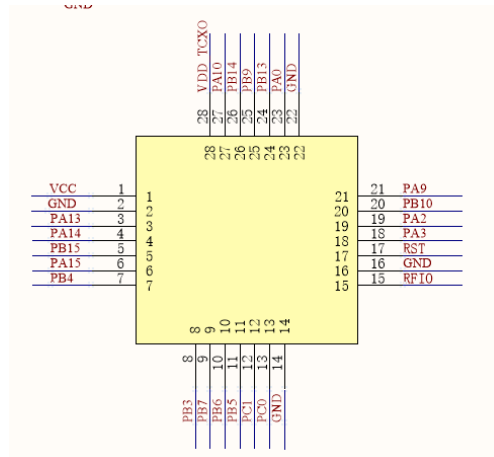

Figure 2 LoRa-E5 Pin arrangement

Table 1 LoRa-E5 pinout

Number	Name	Type	Description
1	VCC	-	Supply voltage for the module
2	GND	-	Ground
3	PA13	I	SWDIO of SWIM for program download
4	PA14	I/O	SWCLK of SWIM for program download
5	PB15	I/O	SCL of I2C2 from MCU
6	PA15	I/O	SDA of I2C2 from MCU
7	PB4	I/O	MCU GPIO
8	PB3	I/O	MCU GPIO
9	PB7	I/O	UART1_RX from MCU
10	PB6	I/O	UART1_TX from MCU
11	PB5	I/O	MCU GPIO
12	PC1	I/O	MCU GPIO ; LPUART1_TX from MCU
13	PC0	I/O	MCU GPIO ; LPUART1_RX from MCU
14	GND	-	Ground
15	RFIO	I/O	RF input/output
16	GND	-	Ground
17	RST	I/O	Reset trigger input for MCU
18	PA3	I/O	MCU GPIO; USART2_RX from MCU
19	PA2	I/O	MCU GPIO; USART2_TX from MCU
20	PB10	I/O	MCU GPIO
21	PA9	I/O	MCU GPIO
22	GND	-	Ground
23	PA0	I/O	MCU GPIO
24	PB13	I/O	SPI2_SCK from MCU; Boot pin(Active low)
25	PB9	I/O	SPI2_NSS from MCU
26	PB14	I/O	SPI2_MISO from MCU
27	PA10	I/O	SPI2_MOSI from MCU
28	PB0	I/O	Unavailable; Suspended treatment

3 Electrical characteristics

3.1 Extreme working conditions

Reaching or exceeding the maximum ratings listed in the table below can cause equipment damage.

Table 2 Absolute Maximum Ratings

Item	Description	min	max	unit
------	-------------	-----	-----	------

VCCmr	Supply voltage	-0.3	+3.9	V
Tmr	Ambient temperature	-40	+85	°C
Pmr	RF input power	-	+10	dBm

3.2 Normal working conditions

Table 3 Recommended Operating Conditions

Item	Description	min	max	unit
VCCop	Supply voltage	+1.8	+3.6	V
Top	Ambient temperature	-40	+85	°C
Pop	RF input power	-	+10	dBm

3.3 Module specifications

Table 4 LoRa-E5 features

ITEMs	Parameter	Specifications				Unit
Structure	Size	12(W) X 12(L) X 2.5(H)				mm
	Package	28 pins, SMT				
Electrical Characteristics	power supply	3.3V type				V
	Sleep current	2.1uA (WDT on);				uA
	Operation current (Transmitter+MCU)	50mA @10dBm in 434MHz type				mA
		111mA @22dBm in 470MHz type				
		111mA @22dBm in 868MHz type				
	Operation current (Receiver+MCU)	6.7mA @BW125kHz, 434MHz type				mA
		6.7mA @BW125kHz, 470MHz type				
		6.7mA @BW125kHz, 868MHz type				
	Output power	10dBm max @434MHz				dBm
		22dBm max @470MHz				
		22dBm max @868MHz				
Sensitivity	@SF12, BW125kHz					
	Fr(MHz)	min	type	max	dBm	
	434	-	-134.5	-136		
	470	-	-136.5	-137.5		
868	-	-135	-137			
Harmonics	<-36dBm below 1GHz				dBm	
	<-40dBm above 1GHz				dBm	
Interface	RFIO	RF port				
	UART	3 group of UART, include 2pins				

I2C	1 group of I2C, include 2 pins	
ADC	1 ADC Input, include 1pins,12-bit 1Msps	
NRST	Manual reset pin input	
SPI	1 group of SPI, include 4 pins	

4 Typical RF performance test

4.1 LoRa-E5-LF Performance Testing

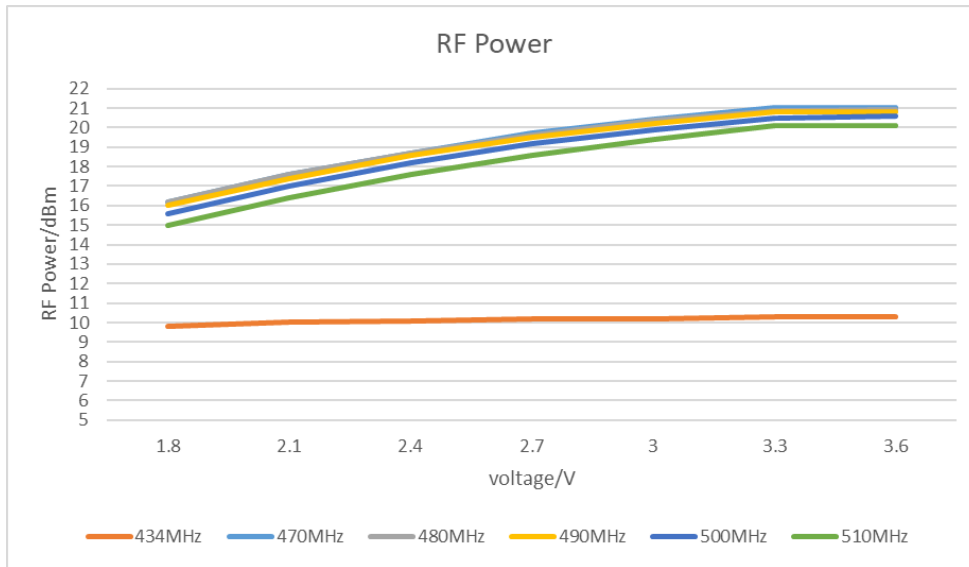

Figure 3 RF Power vs Voltage (434~510MHz)

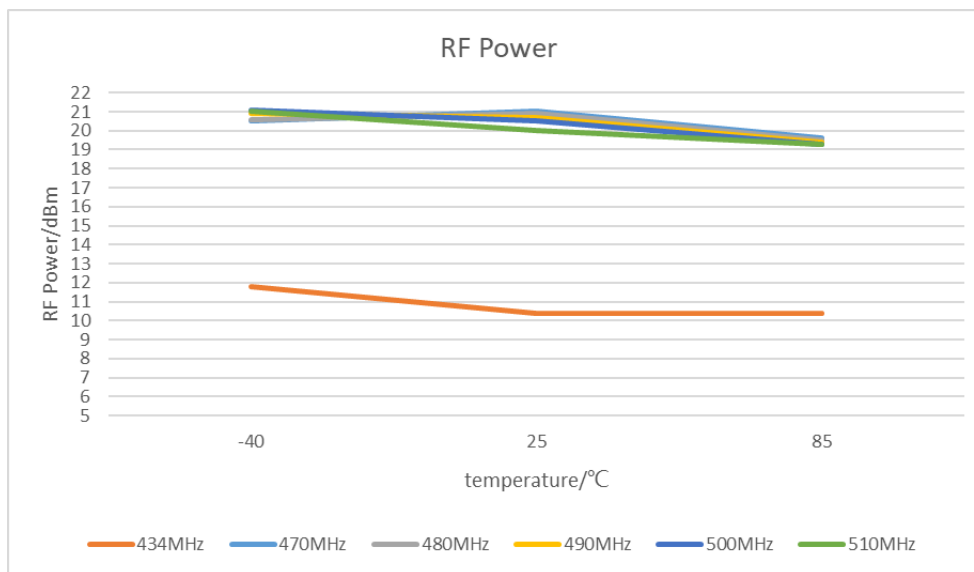

Figure 4 RF Power VS Temperature (434~510MHz)

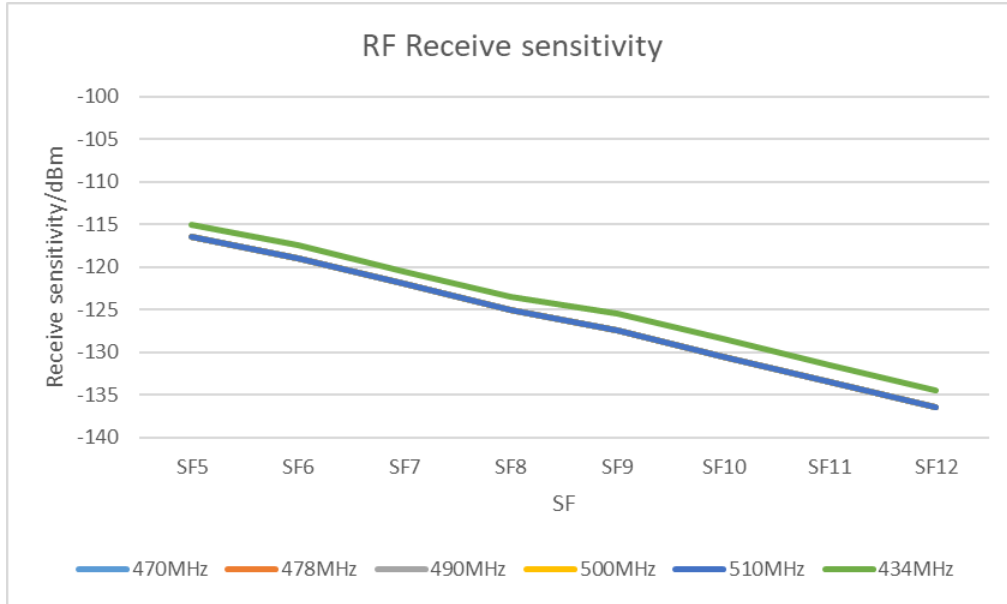

Figure 5 RF Receiver Sensitivity vs Spreading factor (434~510MHz)

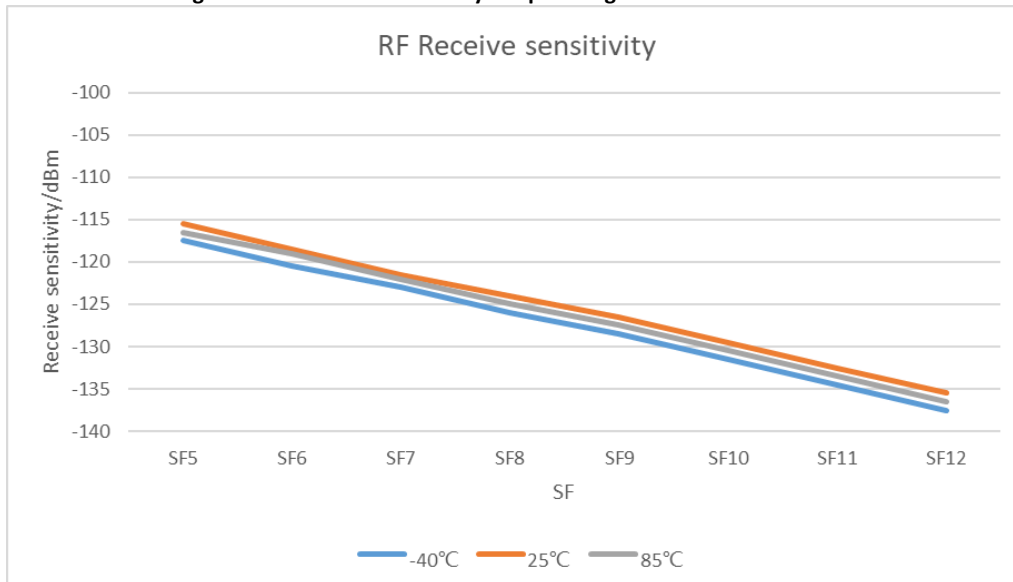

Figure 6 RF Receiver Sensitivity VS Temperature (470MHz)

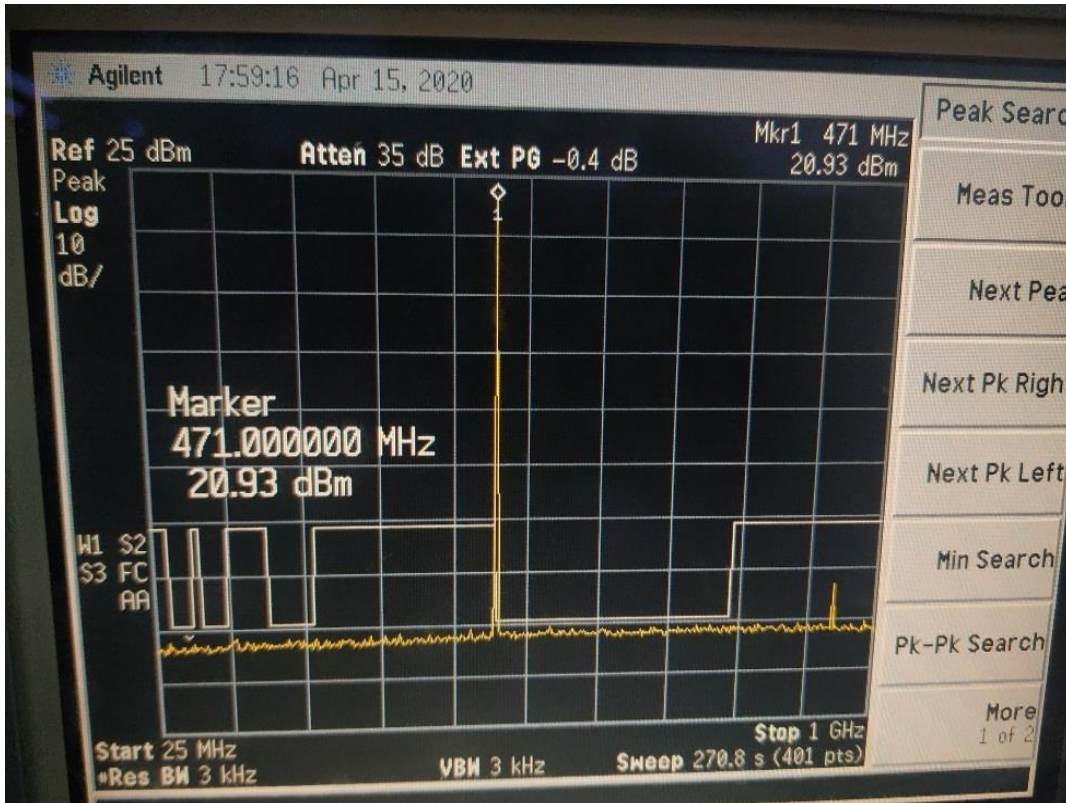

Figure 7 Harmonic(25MHz~1GHz)@Frf=470MHz, TXOP=22dBm

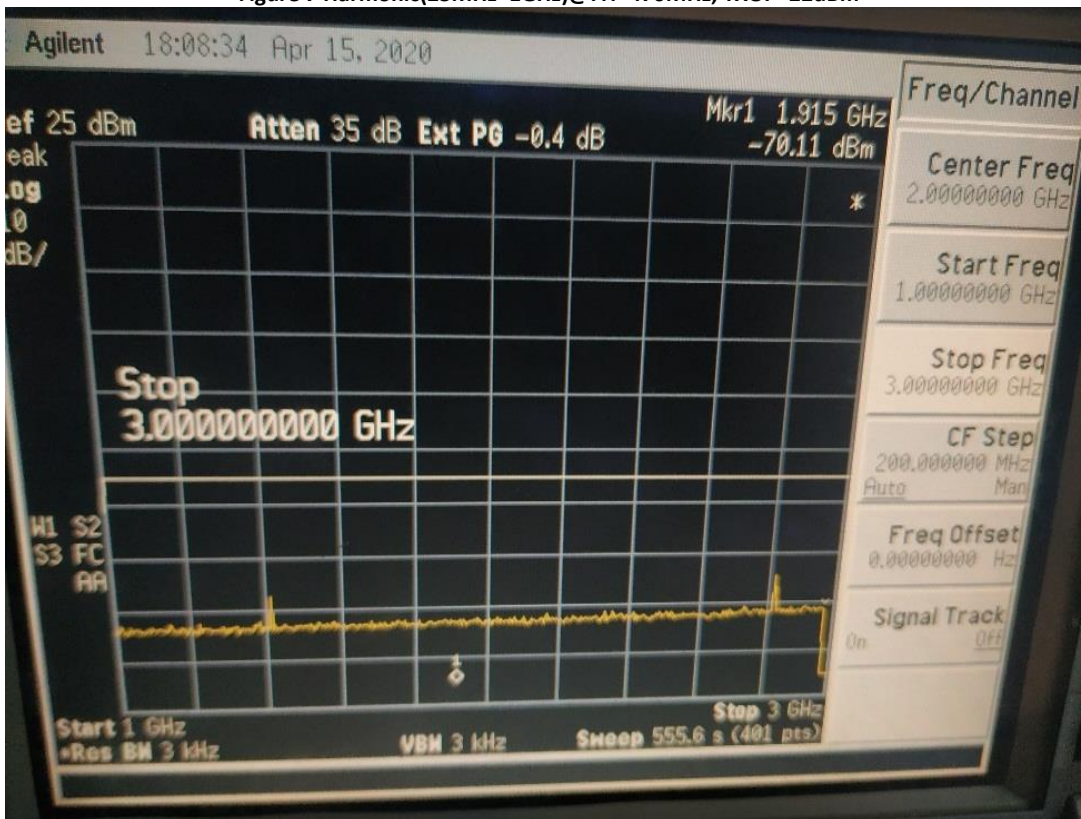

Figure 8 Harmonic(1GHz~3GHz)@Frf=470MHz, TXOP=22dBm

4.2 LoRa-E5-HF Performance Testing

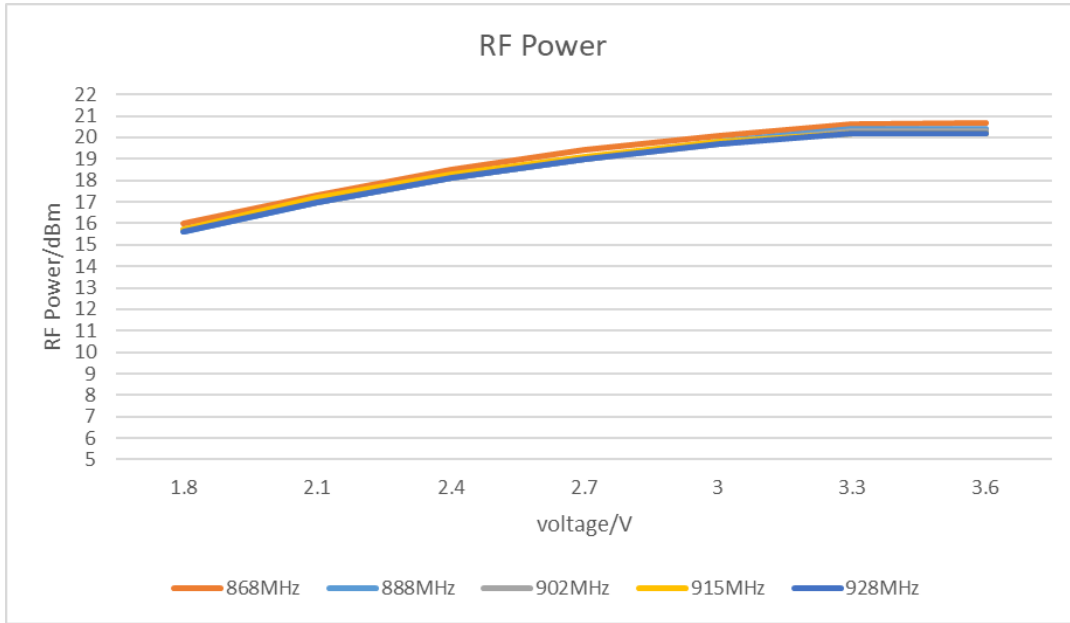

Figure 9 RF Power vs Voltage (868~928MHz)

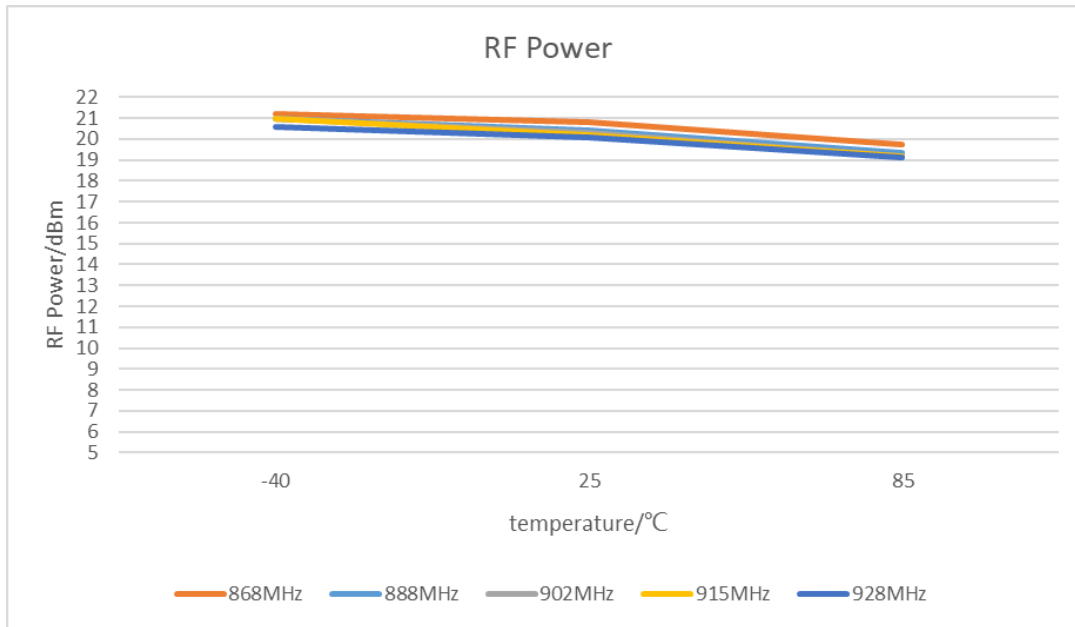

Figure 10 RF Power VS Temperature (868~928MHz)

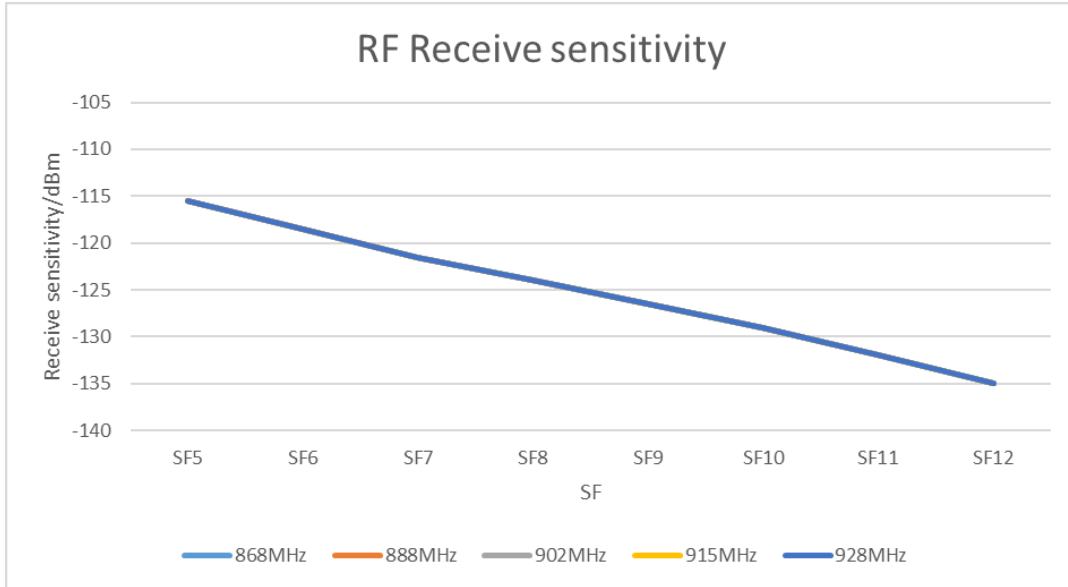

Figure 11 RF Receiver Sensitivity vs Spreading factor (868~928MHz)

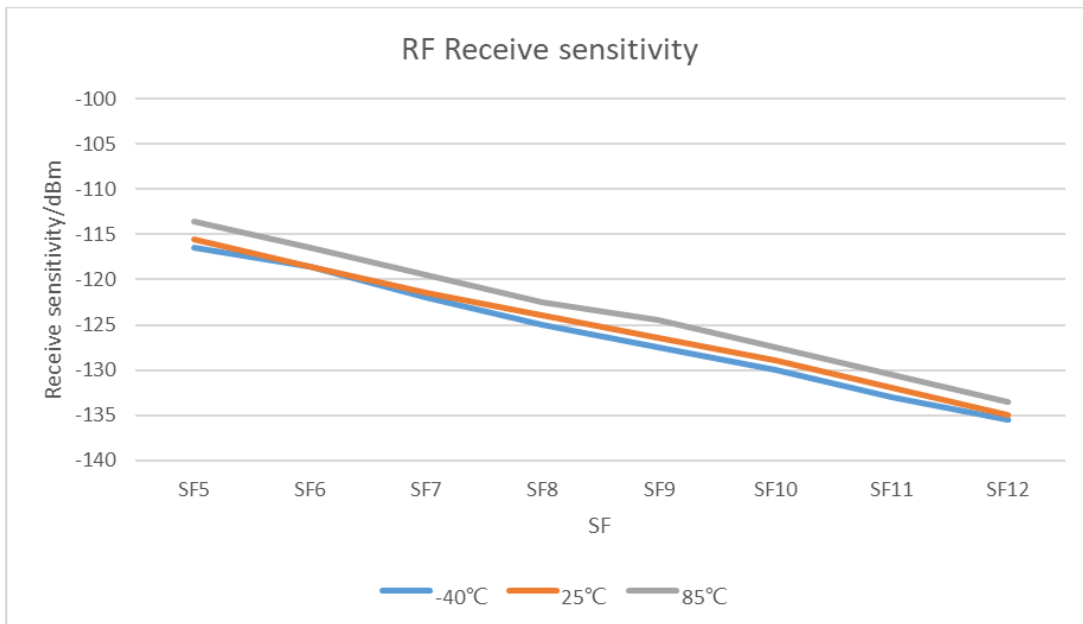

Figure 12 RF Receiver Sensitivity VS Temperature (868MHz)

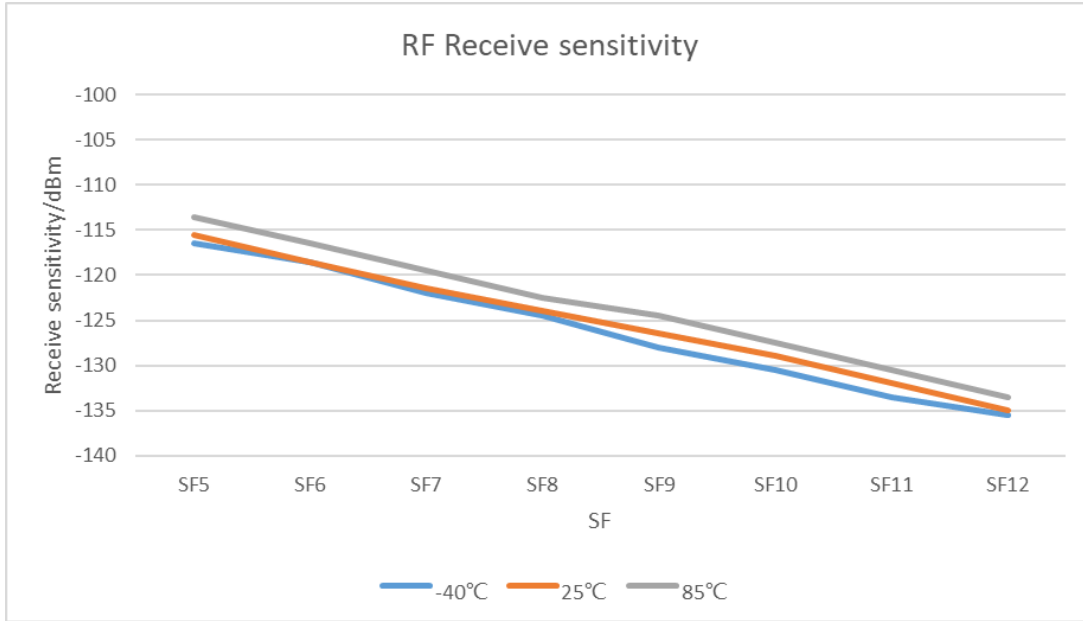

Figure 13 RF Receiver Sensitivity VS Temperature (915MHz)

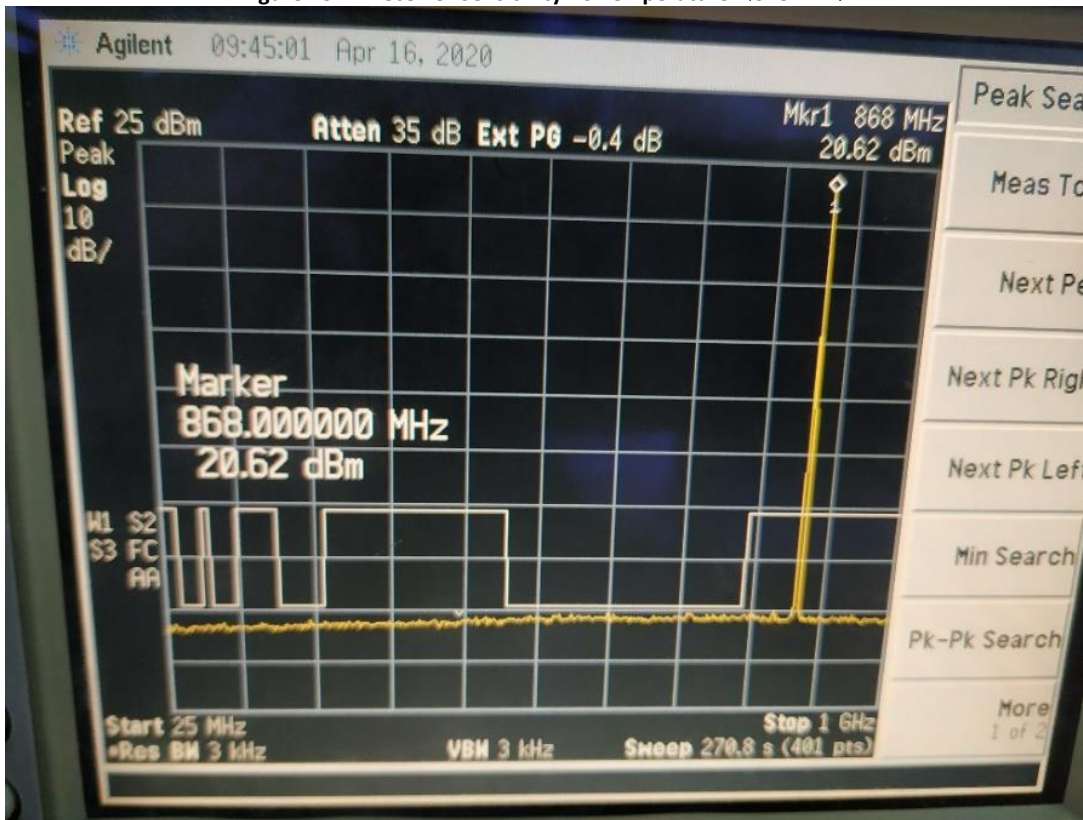

Figure 14 Harmonic(25MHz~1GHz)@Frf=868MHz, TXOP=22dBm

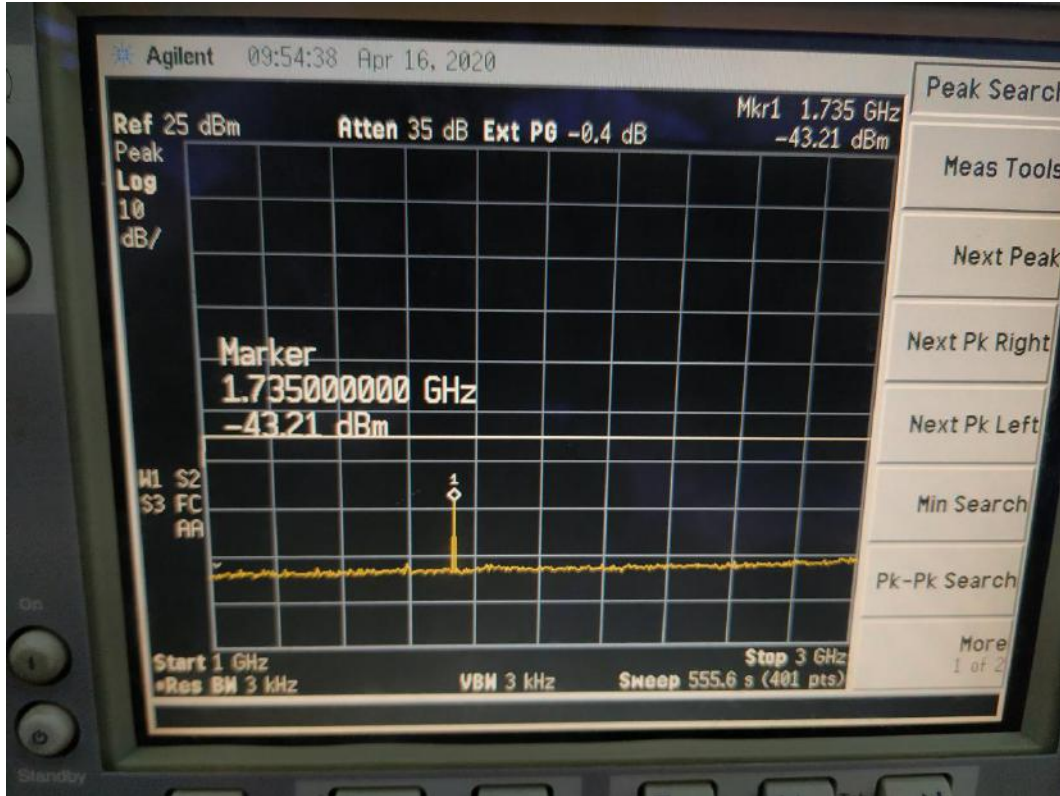

Figure 15 Harmonic(1GHz~3GHz)@Frf=868MHz, TXOP=22dBm

5 Application information

5.1 Package information

LoRa-E5 has a 28-pin SMD package:

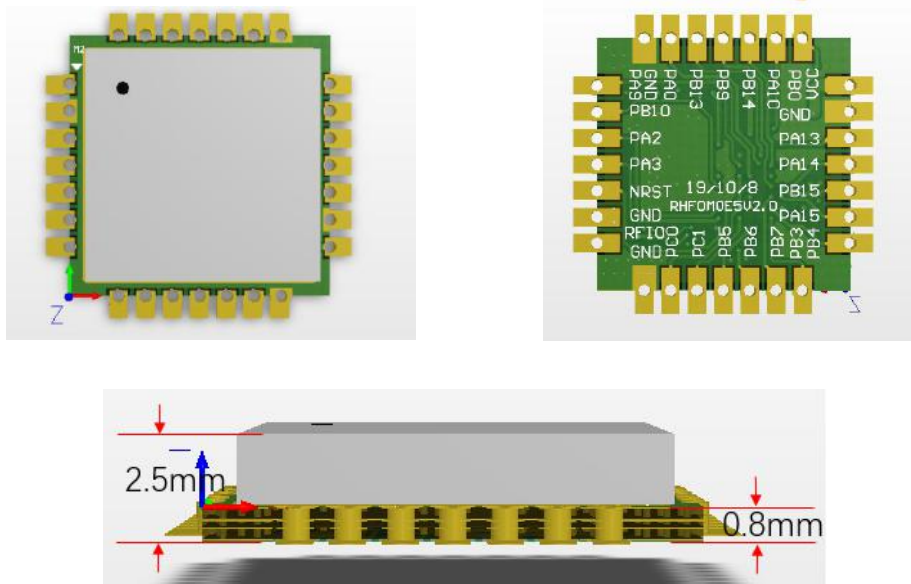

Figure 16 LoRa-E5 Module appearance

The following figure shows the recommended Layout package dimensions.

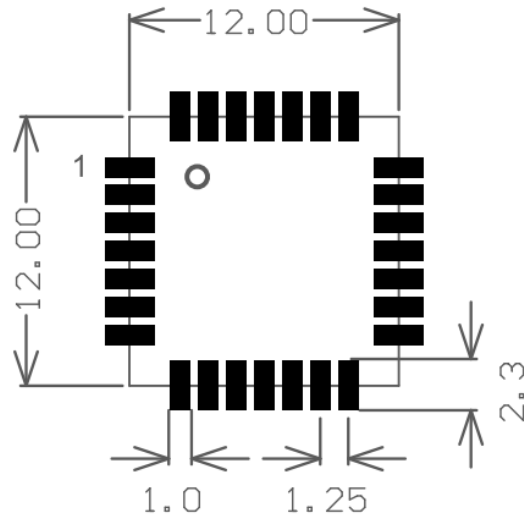

Figure 17 PCB layout

5.2 External interface of the module

In addition to several necessary GPIO ports and a set of SPI ports used for internal RF transceiver control, other GPIOs of the MCU have been derived, including UART (for AT commands), I2C, ADC, etc. For customers who want to develop software on the MCU of the module, these rich GPIO interfaces are very useful for users who need to expand peripherals.

5.3 Reference design based on LoRa-E5 module

LoRa-E5 embeds the global LoRaWAN[®] protocol and AT instruction set. This will make the design of LoRaWAN[®] nodes based on this module very easy. The following is a typical reference design that uses LoRa-E5 to quickly start a LoRaWAN[®] application. Just connect UART and NRST to the host MCU and send AT commands.

In addition, Pin24 grounding of the module will force the module to enter Boot upgrade mode.

Note: The 28-pin PBO must be left floating and not allowed to be pulled up or grounded.

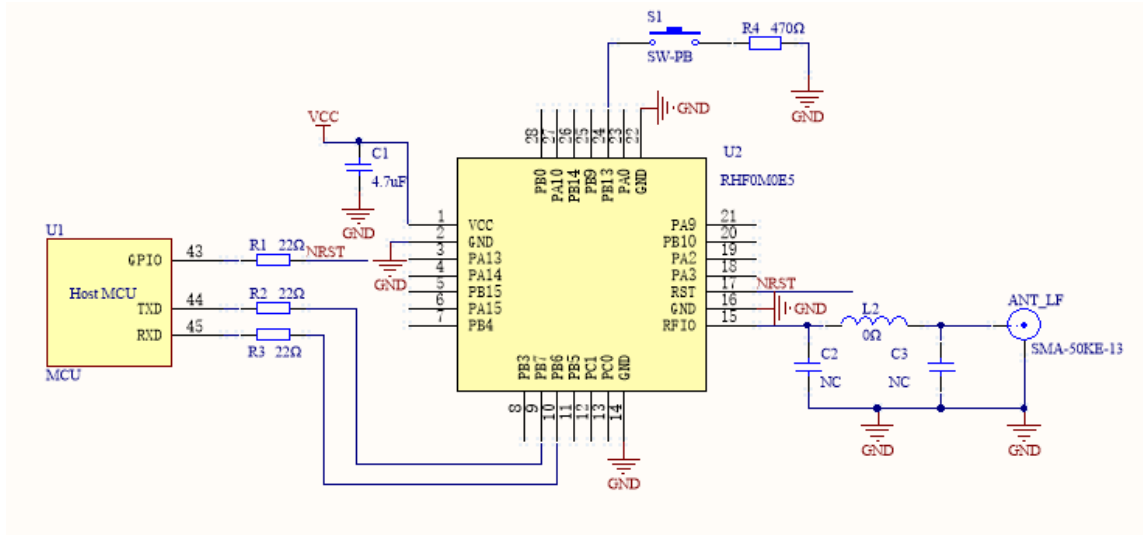

Figure 18 Reference design based on LoRa-E5

6 LoRaWAN[®] application information

6.1 LoRaWAN[®] application

The topology of the LoRaWAN[®] network is a star network, and the gateway acts as a relay between nodes and network servers. The gateway is connected to the network server through a standard IP link, and the node device uses LoRa[®] or FSK to communicate with one or more gateways. Communication is bidirectional, although it is mainly upstream communication from the node to the network server.

The communication between the node and the gateway uses different frequencies and rates. The choice of rate is a compromise between power consumption and distance, and different rates do not interfere with each other. According to different spreading factors and bandwidths, the rate of LoRa[®] can be from 300bps to 50Kbps. In order to maximize battery life and network capacity, the network server manages the node's rate and output power through rate adaptation (ADR).

The node device may transmit on a random channel at any time and at any rate, as long as the following conditions are met:

- 1) The channel currently used by the node is pseudo-random. This makes the system more resistant to interference
- 2) The maximum transmission time (dwell time of the channel) and duty cycle of the node depends on the frequency band used and local regulations

LoRa-E5 module integrates ST ultra-low power IC STM32WLE5JC. The current is only 2.1uA in sleep mode, this module is very suitable for various applications of LoRaWAN[®].

6.2 Design LoRaWAN[®] wireless sensor based on LoRa-E5

LoRa-E5 is an AT instruction set that encapsulates the global LoRaWAN[®] standard protocol. The customer only needs a very simple MCU as the main control, and can control the LoRa-E5 through the serial port, thereby easily implementing the LoRaWAN[®] protocol. This helps customers quickly bring sensor products to the LoRaWAN[®] market.

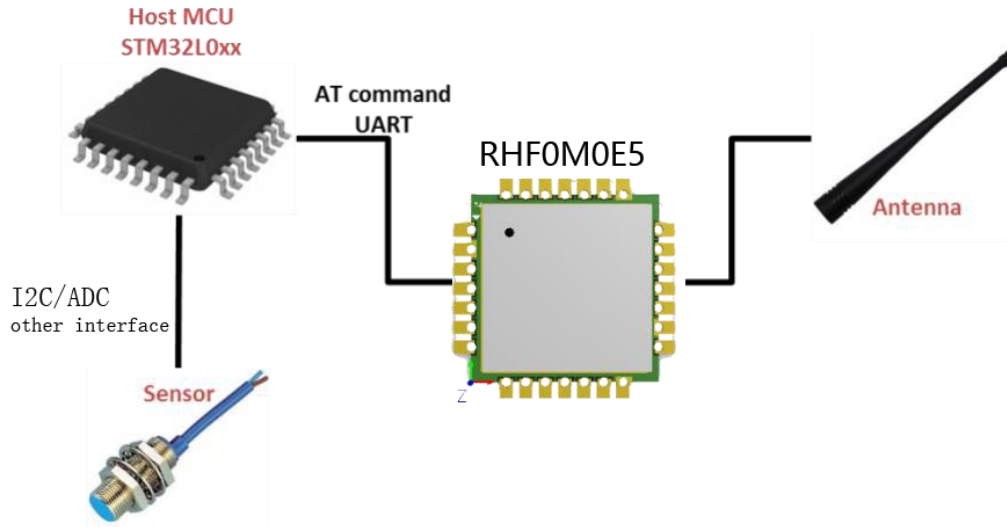

Figure 19 Design of LoRaWAN® wireless sensor based on LoRa-E5 module

7 Ordering information

Technical Support: sensecap@seeed.cc

Sales: iot@seeed.cc

Table 5 Ordering Information

Part Number	MCU	TX Power (dBm)	AT Modem
LoRa-E5-LF	ROM 256KB / RAM 64KB	10@LF(434MHz) 22@LF (470MHz)	Yes
LoRa-E5-HF	ROM 256KB / RAM 64KB	22@HF (868/915MHz)	Yes

8 Reversion

V1.0 2020-07-20 First release

ORIGINAL EQUIPMENT MANUFACTURER (OEM) NOTES

The OEM must certify the final end product to comply with unintentional radiators (FCC Sections 15.107 and 15.109) before declaring compliance of the final product to Part 15 of the FCC rules and regulations. Integration into devices that are directly or indirectly connected to AC lines must add with Class II Permissive Change.

The OEM must comply with the FCC labeling requirements. If the module's label is not visible when installed, then an additional permanent label must be applied on the outside of the finished product which states: "Contains transmitter module FCC ID: Z4T-LORA-E5". Additionally, the following statement should be included on the label and in the final product's user manual: "This device complies with Part 15 of the FCC Rules.

Operation is subject to the following two conditions:

- (1) This device may not cause harmful interferences, and
- (2) this device must accept any interference received, including interference that may cause undesired operation."

The module is limited to installation in mobile or fixed applications. Separate approval is required for all other operating configurations, including portable configuration with respect to Part 2.1093 and different antenna configurations.

A module or modules can only be used without additional authorizations if they have been tested and granted under the same intended end - use operational conditions, including simultaneous transmission operations. When they have not been tested and granted in this manner, additional testing and/or FCC application filing may be required. The most straightforward approach to address additional testing conditions is to have the grantee responsible for the certification of at least one of the modules submit a permissive change application. When having a module grantee file a permissive change is not practical or feasible, the following guidance provides some additional options for host manufacturers. Integrations using modules where additional testing and/or FCC application filing(s) may be required are: (A) a module used in devices requiring additional RF exposure compliance information (e.g., MPE evaluation or SAR testing); (B) limited and/or split modules not meeting all of the module requirements; and (C) simultaneous transmissions for independent collocated transmitters not previously granted together.

This Module is full modular approval, it is limited to OEM installation ONLY.

Integration into devices that are directly or indirectly connected to AC lines must add with Class II Permissive Change. (OEM) Integrator has to assure compliance of the entire end product include the integrated Module. Additional measurements (15B) and/or equipment authorizations (e.g. Verification) may need to be addressed depending on co-location or simultaneous transmission issues if applicable. (OEM) Integrator is reminded to assure that these installation instructions will not be made available to the end user

This equipment complies with FCC RF radiation exposure limits set forth for an uncontrolled environment.

This device complies with Part 15 of the FCC Rules. Operation is subject to the following two conditions:

- (1) This device may not cause harmful interference.
- (2) This device must accept any interference received, including interference that may cause undesired operation.

NOTE: This equipment has been tested and found to comply with the limits for a Class B digital device, pursuant to part 15 of the FCC Rules. These limits are designed to provide reasonable protection against harmful interference in a residential installation. This equipment generates uses and can radiate radio frequency energy and, if not installed and used in accordance with the instructions, may cause harmful interference to radio communications. However, there is no guarantee that interference will not occur in a particular installation. If this equipment does cause harmful interference to radio or television reception, which can be determined by turning the equipment off and on, the user is encouraged to try to correct the interference by one or more of the following measures:

- Reorient or relocate the receiving antenna.
- Increase the separation between the equipment and receiver.
- Connect the equipment into an outlet on a circuit different from that to which the receiver is connected.
- Consult the dealer or an experienced radio/TV technician for help
- This device and its antenna(s) must not be co-located or operating in conjunction with any other antenna or transmitter.

NOTE: The manufacturer is not responsible for any radio or TV interference caused by unauthorized modifications to this equipment. Such modifications could void the user's authority to operate the equipment.